

Brick Specials

Tailor Made
British Standard
Non Standard

CRADLEY

SPECIAL BRICK

a Forterra brand

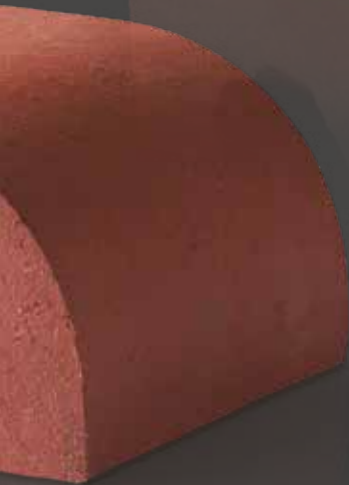
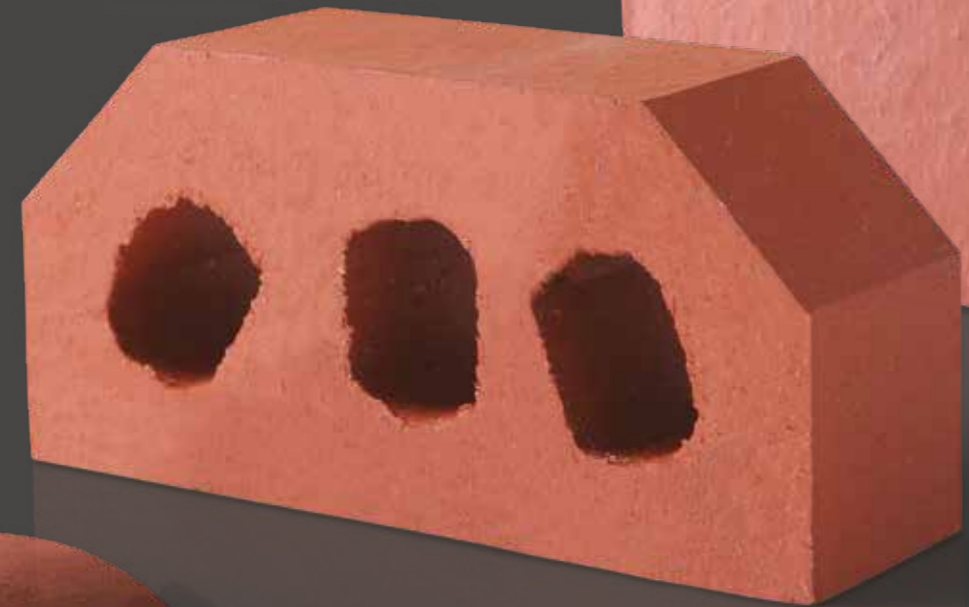

Think Specials Think Cradley

Add value and aesthetics to new builds, extensions, renovations and restorations with Cradley bricks. Cradley focus solely on the manufacture of British standard, non-standard and tailor made special shaped bricks; to any size, any shape and any quantity.

If you want a special, call the Specialists now on 01384 637174 or visit forterra.co.uk/cradley

Tailor Made Brick Specials

Cradley offer a bespoke design and manufacturing service, allowing you to match or create unique one off brick specials for any project.
See pages 8-11



British Standard Brick Specials

Cradley manufacture one of the broadest ranges of British Standard brick specials in the UK, all manufactured to BS 4729.
See pages 12-37



Non Standard Brick Specials

Cradley produce a wide range of bespoke architectural brick specials, to help create unique brickwork features and detailing.
See pages 38-71



Contents

A Guide to Cradley Brick Specials **6**

Tailor Made Brick Specials

Tailor Made Brick Specials **8**

British Standard Brick Specials

Angle & Cant Bricks **14**
Bonding Bricks **20**
Bullnose Bricks **22**
Pistol Bricks **28**
Soldier Bricks **29**
Plinth Bricks **30**
Radial Bricks **34**
Arch Bricks & Systems **35**

Non Standard Brick Specials

Cills **40**
Copings & Cappings **42**
Slips & Spacing Bricks **50**
Renovation Specials & Restoration **52**
Large Format Pier Caps **61**
Bat & Swift Boxes **62**
Personalised & Date Bricks **60**
Cut & Bond Bricks **63**
Clay Pavers **64**

Design Considerations

Frost Protection **72**
Brick Colour Guide **74**
Texture Guide & Bond Patterns **75**
Mortar Colours & Joint Profiles **76**
Ordering Information **77**
Contact Us **78**

A Guide to Cradley Brick Specials

View our interactive house at forterra.co.uk/cradley



- 1** Large Format Pier Caps
page 61
- 2** Copings & Cappings
page 42
- 3** Bat & Swift Boxes
page 62
- 4** Cill Bricks
page 40
- 5** Pistol & Soldier Bricks
page 28
- 6** Arch Bricks & Arch Systems
page 35
- 7** Personalised & Date Bricks
page 60
- 8** Decorative Bricks
page 60
- 9** Angle & Cant Bricks
page 14
- 10** Pavers & Kerbs
page 64
- 11** Bullnose Bricks
page 22
- 12** Cut & Bond Bricks
page 63
- 13** String Courses
page 59
- 14** Plinth Bricks
page 30
- 15** Radial Bricks
page 34

Tailor Made Brick Specials

Cradley offer a bespoke design and manufacturing service, allowing you to match or create unique one off brick specials for any project.



Bespoke Crafted Character Bricks



Quality and craftsmanship - working hand in hand. Cradley already has over 7,323 (and counting) unique patterns for producing tailor made brick specials.

The British have, for many decades, held a keen interest in historic buildings, and in recent years we have enjoyed a resurgence of pride in British quality and craftsmanship, aided by numerous organisations and societies promoting the sustainable renovation and maintenance of historic buildings.

Special shaped bricks have historically been employed to help create buildings of character and individuality that have formed and enhanced our architectural heritage.

Today, the use of special shaped bricks can provide architects and developers considerable scope in the design and build of imaginative and inspiring buildings, by incorporating them into both traditional and modern construction techniques.



Radial Bricks in Dark Multi Smooth



Special Arch Brick Detail in Smooth Red



Tailor made Smooth Blue

Imperial Bricks

In addition to our standard range of bricks, we offer a full range of imperial sized bricks at 215 x 102.5 x 73mm. Imperial sized bricks are ideal for extensions and refurbishment projects.



British Standard Brick Specials

Cradley manufacture one of the broadest ranges of British Standard brick specials in the UK, all manufactured to BS 4729.

Angle & Cant Bricks

Bonding Bricks

Bullnose Bricks

Pistol Bricks

Soldier Bricks

Plinth Bricks

Radial Bricks

Arch Bricks & Systems

Brick Specials Regular range

PL.3 Plinth stretcher

Type	A	B	C	D	E	∞
PL.3.1	215	102	65	9	46	45°
PL.3.2	215	102	65	23	60	45°

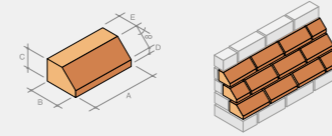

BN.2 Double bullnose

Type	A	B	C	R
BN.2.1	215	102	65	25
BN.2.2	215	102	65	51

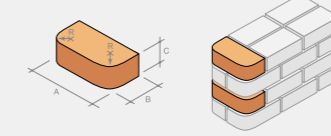

AN.5 Single cant

Left or right hand, if surface has textured finish.

Type	A	B	C	D	E
AN.5.1	215	102	65	46	159
AN.5.2	215	102	65	60	173

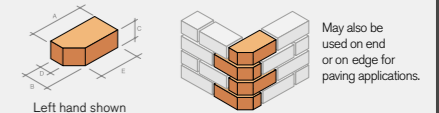

PL.2 Plinth header

Type	A	B	C	D	E	∞
PL.2.1	215	102	65	9	159	45°
PL.2.2	215	102	65	23	173	45°

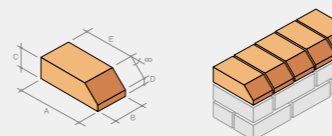

BN.1 Single bullnose

Left or right hand - if surface has textured finish.

Type	A	B	C	R
BN.1.1	215	102	65	25
BN.1.2	215	102	65	51

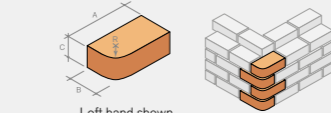

AN.6 Double cant

Type	A	B	C	D	E
AN.6.1	215	102	65	46	103
AN.6.2	215	102	65	60	131

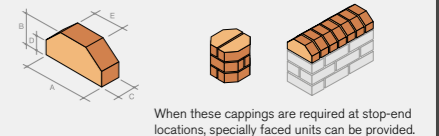

CP.2.2 Saddleback capping

Type	A	B	C	D
CP.2.2	215	123	65	50



When these cappings are required at stop-end locations, specially faced units can be provided.

CS.1 Cill brick

Type	A	B	C	D	E
CS.1.1	140	140	65	50	50
CS.1.2	140	140	65	65	65
CS.1.3	150	140	65	65	65
CS.1.4	170	140	65	50	80
CS.1.9	150	140	65	50	55
CS.1.10	190	140	65	65	65

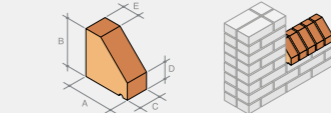

BN.13 Bullnose double header on flat

Type	A	B	C	R
BN.13.1	215	102	65	25
BN.13.2	215	102	65	51

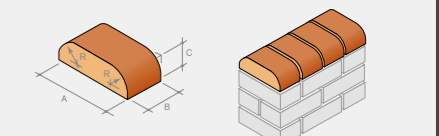

CP.1.2 Half round capping

Type	A	B	C
CP.1.2	215	108	65

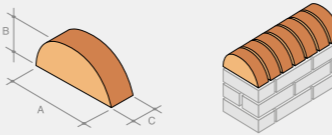

When these cappings are required at stop-end locations, specially faced units can be provided.

CS.2 Cill brick

Type	A	B	C	D	E	F
CS.2.1	140	140	65	35	15	65
CS.2.2	150	140	65	36	15	65
CS.2.3	150	140	65	40	15	65
CS.2.4	190	140	65	50	15	65

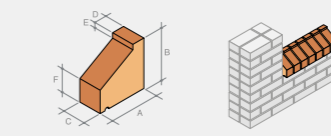

AN.1 Squint

Left or right hand - if surface has textured finish.

Type	A	B	C	D	E	∞
AN.1.1	164	102	65	51	89	30
AN.1.2	164	102	65	51	94	45
AN.1.3	164	102	65	51	117	60

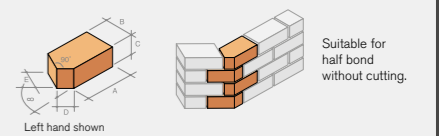

The Cradley regular range of brick specials are available ex stock and competitively priced. For other products please refer to our brick specials brochure or visit forterra.co.uk/cradley

Angle & Cant Bricks

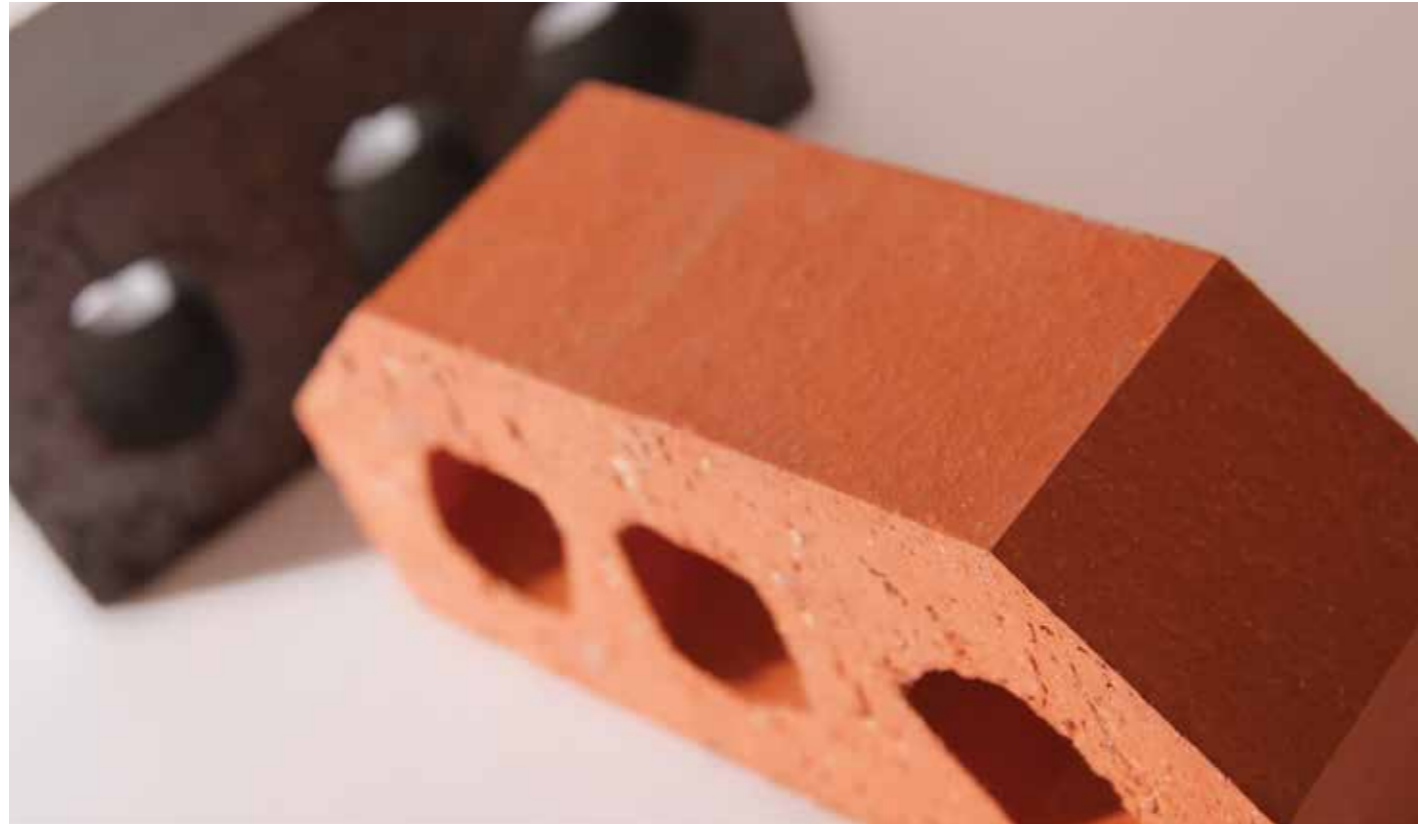

Angle bricks allow brickwork to turn through 30, 45 and 60 degree angles in plan with various bonding patterns.

The cant range allows splay detailing to be achieved within brickwork to window surrounds, corner details and other locations.

AN.1
Squint

Left or right hand - if surface has textured finish.

Type	A	B	C	D	E	∞
AN.1.1	164	102	65	51	89	30°
AN.1.2	164	102	65	51	94	45°
AN.1.3	164	102	65	51	117	60°

Left hand shown

Suitable for half bond without cutting.

AN.2
External angle

Left or right hand - if surface has textured finish.

Type	A	B	C	D	∞
AN.2.1	159 ¹	102	65	102	30°
AN.2.2	159 ¹	102	65	102	45°
AN.2.3	159 ¹	102	65	102	60°
AN.2.4	215 ²	102	65	102	30°
AN.2.5	215 ²	102	65	102	45°
AN.2.6	215 ²	102	65	102	60°

Left hand shown

¹ Suitable for quarter bond without cutting.
² Suitable for half bond without cutting.
Some types of bricks may not be available with A = 215mm.

AN.3
Internal angle/dog leg

Left or right hand, if surface has textured finish.

Type	A	B	C	D	∞
AN.3.1	164 ²	102	65	51	30°
AN.3.2	164 ²	102	65	51	45°
AN.3.3	164 ²	102	65	51	60°
AN.3.4	159 ¹	102	65	102	30°
AN.3.5	159 ¹	102	65	102	45°
AN.3.6	159 ¹	102	65	102	60°
AN.3.7	215 ²	102	65	102	30°
AN.3.8	215 ²	102	65	102	45°
AN.3.9	215 ²	102	65	102	60°

Left hand shown

¹ Suitable for quarter bond without cutting.
² Suitable for half bond without cutting.
Some types of bricks may not be available with A = 215mm.

AN.4
Birdsmouth

Type	A	B	C	∞
AN.4.1	215	102	65	120°
AN.4.2	215	102	65	135°
AN.4.3	215	102	65	150°

Left hand shown

AN.5
Single cant

Left or right hand, if surface has textured finish.

Type	A	B	C	D	E
AN.5.1	215	102	65	46	159
AN.5.2	215	102	65	60	173

Left hand shown

May also be used on end or on edge for paving applications.

AN.6
Double cant

Type	A	B	C	D	E
AN.6.1	215	102	65	46	103
AN.6.2	215	102	65	60	131

Left hand shown

When these cappings are required at stop-end locations, specially faced units can be provided.

Angle & Cant Bricks

AN.7
Single cant external return

Type	A	B	C	D	E
AN.7.1	215	215	102	46	159
AN.7.2	215	215	102	60	173

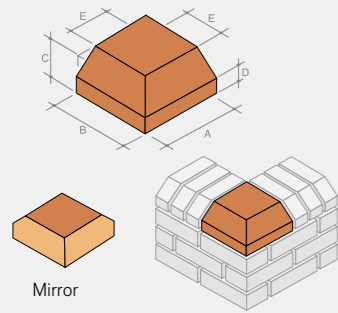

AN.8
Single cant internal return with internal mitre

Square external corners on bed.

Type	A	B	C	D	E
AN.8.1	215	215	102	46	159
AN.8.2	215	215	102	60	173

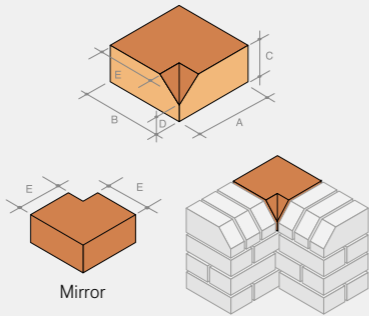

Faced on two full stretchers.

AN.9
Single cant internal return with internal slope

Square external corners on bed.

Type	A	B	C	D	E
AN.9.1	215	215	102	46	159
AN.9.2	215	215	102	60	173

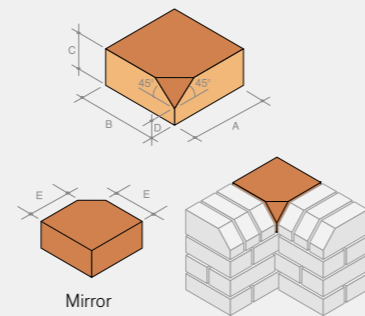

Faced on two full stretchers.

AN.10
Single cant external angle

Type	A	B	C	D	E	F	∞
AN.10.1	215	102	159	46	159	101	30°
AN.10.2	215	102	159	60	173	101	30°
AN.10.3	215	102	159	46	159	70	45°
AN.10.4	215	102	159	60	173	70	45°
AN.10.5	215	102	159	46	159	35	60°
AN.10.6	215	102	159	60	173	35	60°

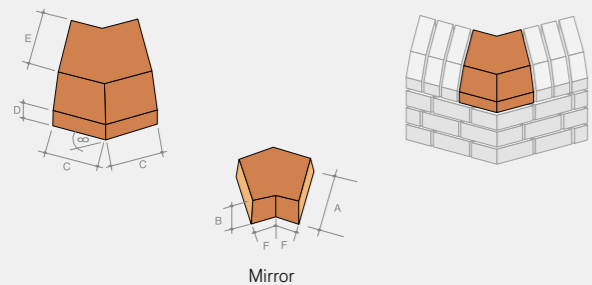

AN.11
Single cant internal angle

Type	A	B	C	D	E	F	∞
AN.11.1	215	102	159	46	159	101	30°
AN.11.2	215	102	159	60	173	101	30°
AN.11.3	215	102	159	46	159	70	45°
AN.11.4	215	102	159	60	173	70	45°
AN.11.5	215	102	159	46	159	35	60°
AN.11.6	215	102	159	60	173	35	60°

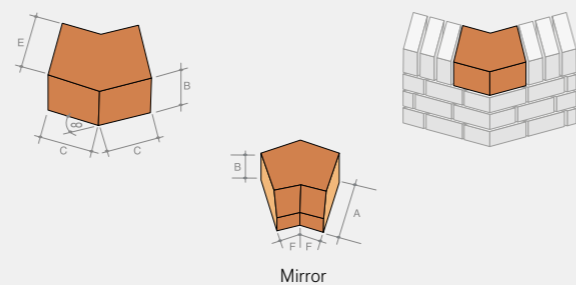

Angle & Cant Bricks

AN.12 Double cant stop end

Square corners on bed.

Type	A	B	C	D	E	F
AN.12.1	215	215	102	46	103	159
AN.12.2	215	215	102	60	131	173

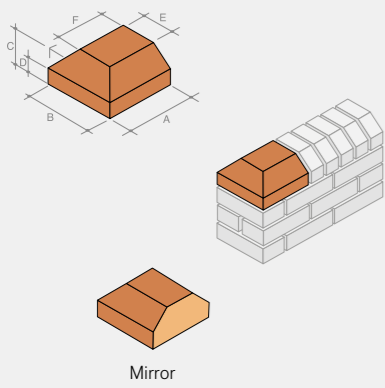

AN.13 Double cant stop end

Canted corners on bed.

Type	A	B	C	D	E	F
AN.13.1	215	215	102	46	103	159
AN.13.2	215	215	102	60	131	173

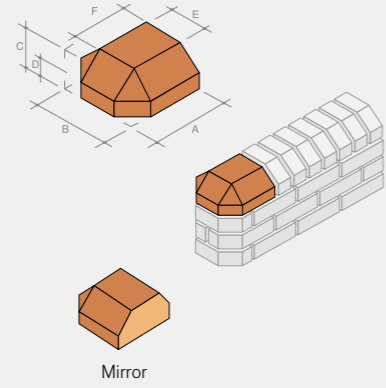

AN.14 Double cant external return with internal mitre

Square corners on bed.

Type	A	B	C	D	E
AN.14.1	215	215	102	46	103
AN.14.2	215	215	102	60	131

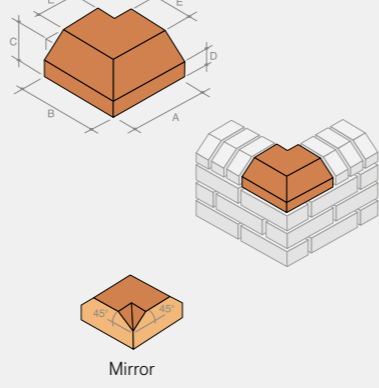

AN.15 Double cant external return with internal mitre

Canted corners on bed.

Type	A	B	C	D	E	F
AN.15.1	215	215	102	46	103	159
AN.15.2	215	215	102	60	131	173

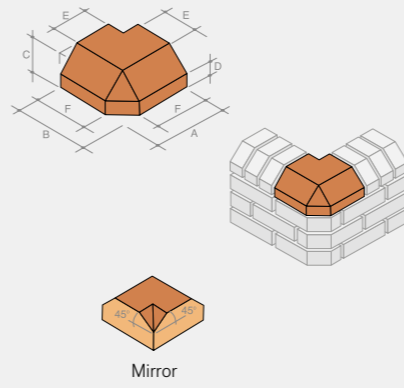

AN.16 Double cant external return with internal slope

Square corners on bed.

Type	A	B	C	D	E
AN.16.1	215	215	102	46	103
AN.16.2	215	215	102	60	131

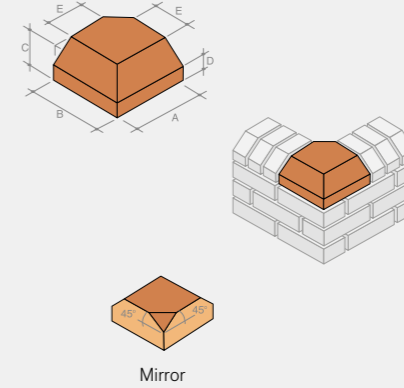

AN.17 Double cant external return with internal slope

Canted corners on bed.

Type	A	B	C	D	E	F
AN.17.1	215	215	102	46	103	159
AN.17.2	215	215	102	60	131	173

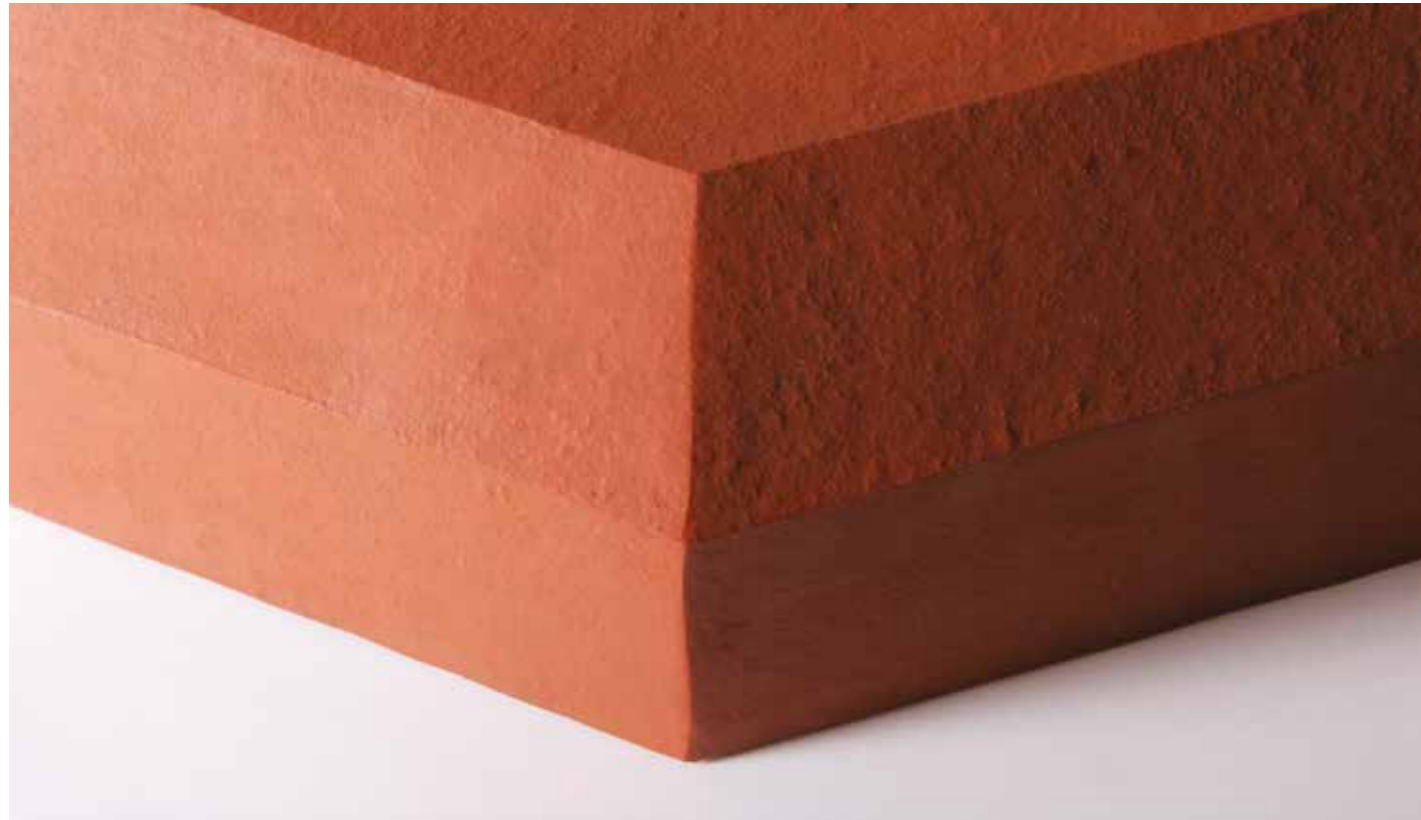
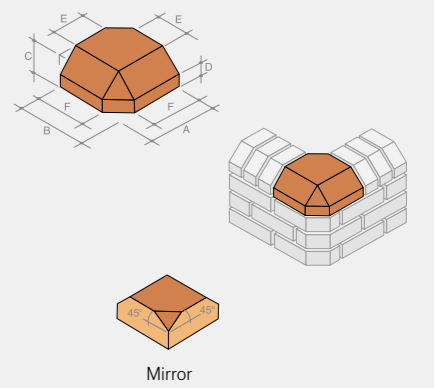

AN.18 Double cant angle

Type	A	B	C	D	E	F	∞
AN.18.1	215	102	159	46	103	101	30°
AN.18.2	215	102	159	60	131	101	30°
AN.18.3	215	102	159	46	103	70	45°
AN.18.4	215	102	159	60	131	70	45°
AN.18.5	215	102	159	46	103	35	60°
AN.18.6	215	102	159	60	131	35	60°

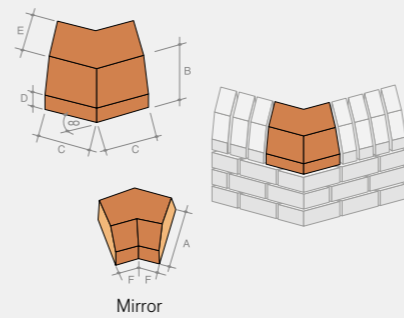

May be supplied in sections.

AN.19 Double cant 'T' junction

Type	A	B	C	D	E	F
AN.19.1	215	215	102	46	103	56
AN.19.2	215	215	102	60	131	42

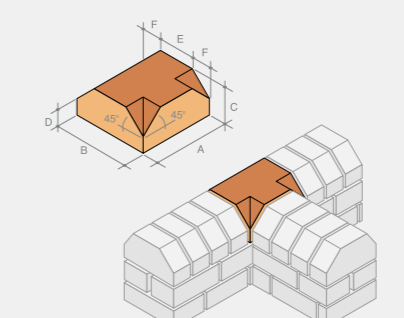

PC.1 Canted pier cap

Also see coping and capping section.

Type	A	B	C	D	E
PC.1.1	215	215	102	46	103
PC.1.2	215	215	102	60	131
PC.1.3	215	215	65	9	103
PC.1.4	215	215	65	23	131

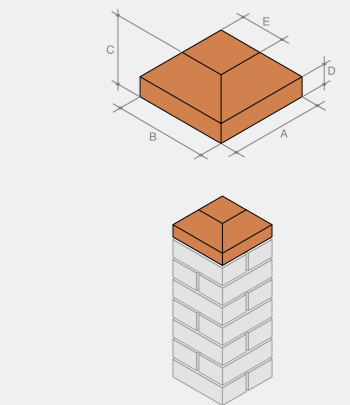

Bonding Bricks



The bonding brick range covers special shaped bricks used to create brick bonding in solid walls without the need for cutting bricks on site.

English, English Garden Wall and Flemish bonds can also be constructed using these specials.

BD.1.1 Half bat/snap header

Type	A	B	C
BD.1.1	102	102	65

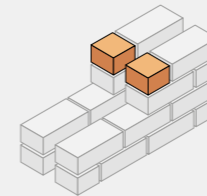
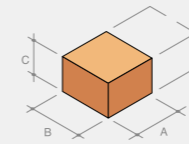

Can be supplied face on bed.

BD.1.2 Three quarter bat

Left or right hand - if surface has textured finish.

Type	A	B	C
BD.1.2	159	102	65

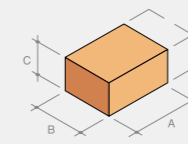

Left hand shown

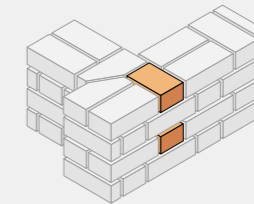

BD.1.3 Standard brick

Faced on bed surface.

Type	A	B	C
BD.1.3	215	102	65

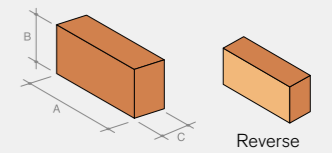

Reverse

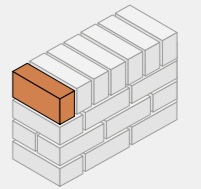

Faced on two headers, one stretcher and one bed.

BD.2 King closer

Left or right hand - if surface has textured finish.

Type	A	B	C	D	E
BD.2	215	102	65	102	46

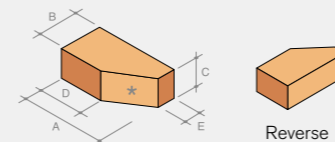

Left hand shown

Reverse

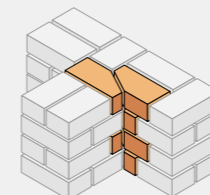

BD.2 can be supplied with an additional face (*) and can therefore be used as a cill brick.

BD.3 Queen closer

Type	A	B	C
BD.3	215	46	65

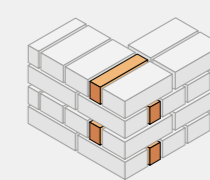
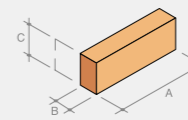

BD.4 215mm stop end

Type	A	B	C
BD.4.1	215	159	102
BD.4.2	215	159	65
BD.4.3	215	215	102
BD.4.4	215	215	65

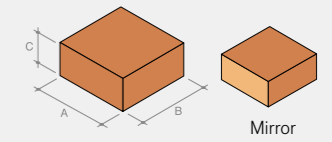

Mirror

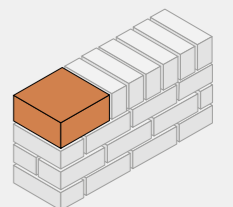

Bullnose Bricks

Bullnoses are a popular range of special shaped bricks which have long been used to soften the aesthetics on walls, around openings or to the corner detailing of buildings.



BN.4 Double bullnose stop

Type	A	B	C	D	R
BN.4.1	215	102	65	25	25
BN.4.2	215	102	65	25	51

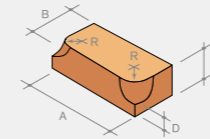

Mirror

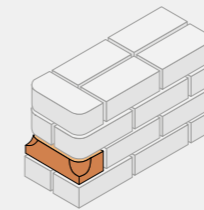

BN.5 Single bullnose header on flat

Type	A	B	C	R
BN.5.1	215	102	65	25
BN.5.2	215	102 </td <td>65</td> <td>51</td>	65	51

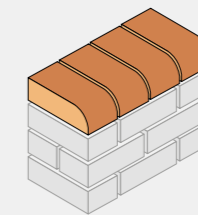
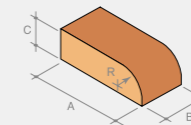

BN.6 Single bullnose stretcher on flat

Type	A	B	C	R
BN.6.1	215	102	65	25
BN.6.2	215	102	65	51

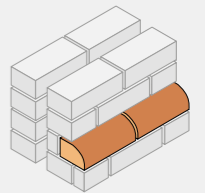
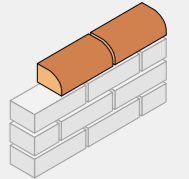
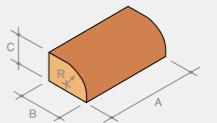

BN.1 Single bullnose

Left or right hand - if surface has textured finish.

Type	A	B	C	R
BN.1.1	215	102	65	25
BN.1.2	215	102	65	51

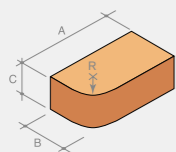

Left hand shown

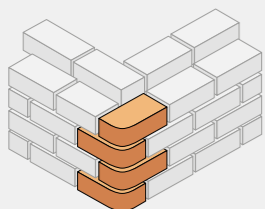

BN.2 Double bullnose

Type	A	B	C	R
BN.2.1	215	102	65	25
BN.2.2	215	102	65	51

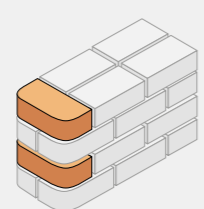
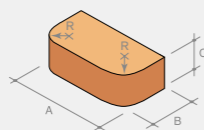

BN.3 Single bullnose stop

Type	A	B	C	D	R
BN.3.1	215	102	65	25	25
BN.3.2	215	102	65	25	51

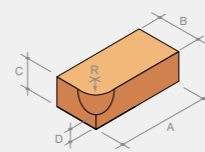

Left hand shown

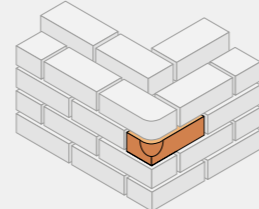

BN.7 Single bullnose internal return

Left or right hand.

Type	A	B	C	R
BN.7.1	215	102	65	25
BN.7.2	215	102	65	51

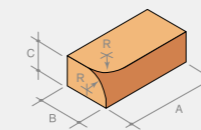

Left hand shown

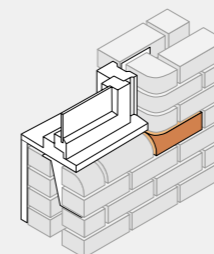

BN.7 Single bullnose internal mitre

Type	A	B	C	R
BN.7.3	215	102	215	25
BN.7.4	215	102	215	51

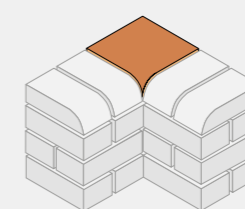
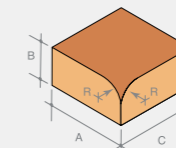

BN.8 Single bullnose internal return

Left or right hand, header-faced.

Type	A	B	C	R
BN.8.1	215	102	65	25
BN.8.2	215	102	65	51

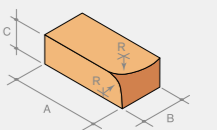

Right hand shown

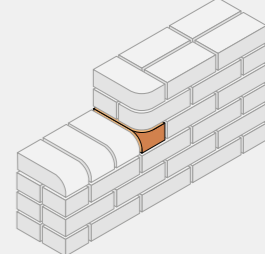

Bullnose Bricks

BN.8 Single bullnose soldier internal return

Header-faced.

Type	A	B	C	R
BN.8.3	215	102	102	25
BN.8.4	215	102	102	51

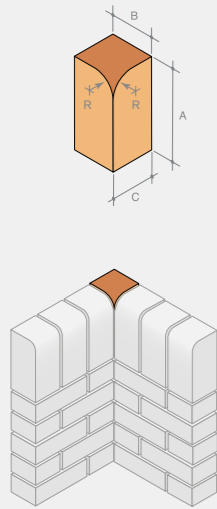

BN.9 Bullnose internal return

Left or right hand, flat-faced.

Type	A	B	C	R
BN.9.1	215	102	65	25
BN.9.2	215	102	65	51

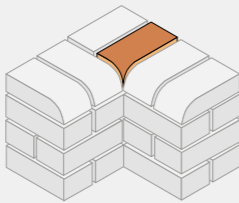
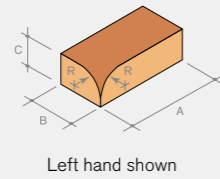

BN.10 Single bullnose external return on edge - brick size

Left or right hand.

Type	A	B	C	R
BN.10.1	215	65	102	25
BN.10.2	215	65	102	51

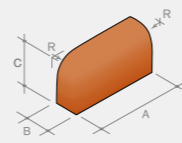

Left hand shown



Mirror

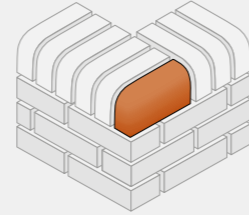

BN.12 Bullnose mitre

Left or right hand.

Type	A	B	C	R
BN.12.1	215	102	65	25
BN.12.2	215	102	65	51

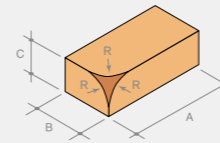

Left hand shown

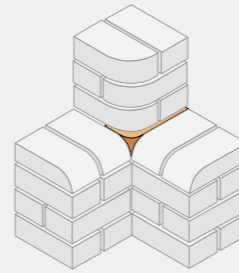

BN.13 Bullnose double header on flat

Header-faced.

Type	A	B	C	R
BN.13.1	215	102	65	25
BN.13.2	215	102	65	51

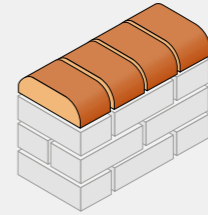
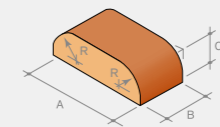

BN.14 Bullnose double stretcher on flat

Header-faced.

Type	A	B	C	R
BN.14.1	215	102	65	25
BN.14.2	215	102	65	51

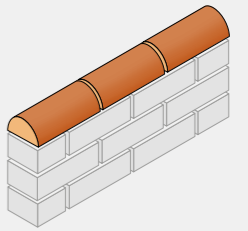
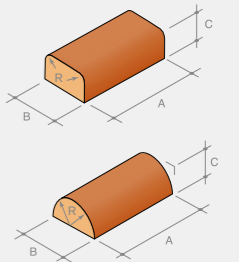

BN.10 Single bullnose external return on edge - block size

Type	A	B	C	R
BN.10.3	215	215	102	25
BN.10.4	215	215	102	51

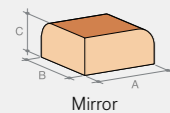
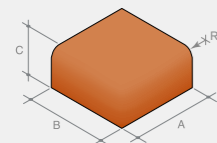

Mirror

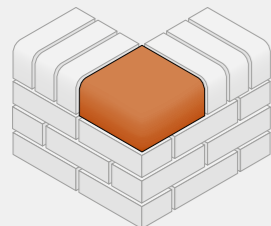

BN.11 Bullnose external return on flat - brick size

Left or right hand.

Type	A	B	C	R
BN.11.1	215	102	65	25
BN.11.2	215	102	65	51

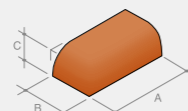

Left hand shown

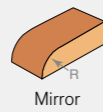

Mirror

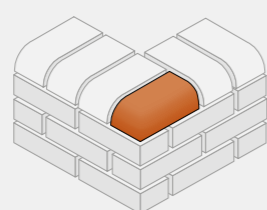

BN.11 Bullnose external return on flat - block size

Type	A	B	C	R
BN.11.3	215	215	65	25
BN.11.4	215	215	65	51

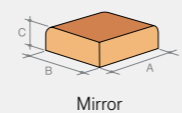
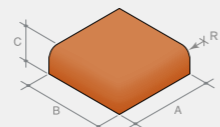

Mirror

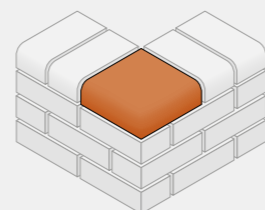

BN.15 Stop end to double bullnose - square corners on bed

To bullnose double header on flat (on edge).

Type	A	B	C	R
BN.15.1	215	159	102	25
BN.15.2	215	159	102	51
BN.15.3	215	215	102	25
BN.15.4	215	215	102	51
BN.15.5	215	159	65	25
BN.15.6	215	159	65	51
BN.15.7	215	215	65	25
BN.15.8	215	215	65	51

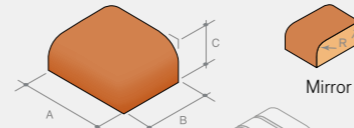

Mirror

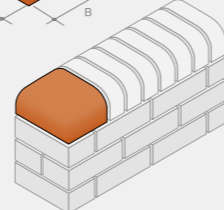

BN.16 Cownose

Type	A	B	C	R
BN.16.1	215	102	65	25
BN.16.2	215	102	65	51

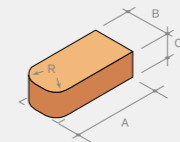

Mirror

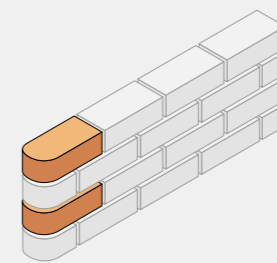

Bullnose Bricks

BN.17

Cownose stop

Type	A	B	C	D	R
BN.17.1	215	102	65	25	25
BN.17.2	215	102	65	25	51

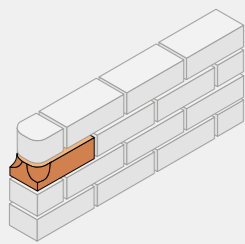
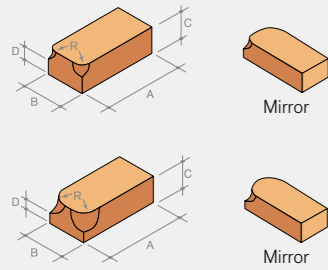

BN.18

Stop end to double bullnose - rounded corners on bed

To bullnose double header on flat or on edge.

Type	A	B	C	R
BN.18.1	215	159	102	25
BN.18.2	215	159	102	51
BN.18.3	215	215	102	25
BN.18.4	215	215	102	51
BN.18.5	215	159	65	25
BN.18.6	215	159	65	51
BN.18.7	215	215	65	25
BN.18.8	215	215	65	51

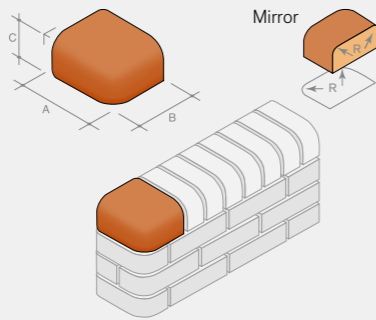

BN.19

External return to double bullnose - square corners on bed

To bullnose double header on flat or on edge.

Type	A	B	C	R
BN.19.1	215	215	102	25
BN.19.2	215	215	102	51
BN.19.3	215	215	65	25
BN.19.4	215	215	65	51

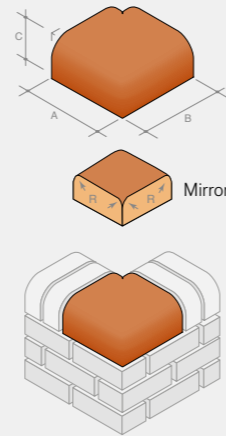

BN.22

Single bullnose external angle to single bullnose

To bullnose single header on flat or on edge.

Type	A	B	C	D	R	∞
BN.22.1	215	102	159	101	25	30°
BN.22.2	215	102	159	101	51	30°
BN.22.3	215	65	159	101	25	30°
BN.22.4	215	65	159	101	51	30°
BN.22.5	215	102	159	70	25	45°
BN.22.6	215	102	159	70	51	45°
BN.22.7	215	65	159	70	25	45°
BN.22.8	215	65	159	70	51	45°
BN.22.9	215	102	159	35	25	60°
BN.22.10	215	102	159	35	51	60°
BN.22.11	215	65	159	35	25	60°
BN.22.12	215	65	159	35	51	60°

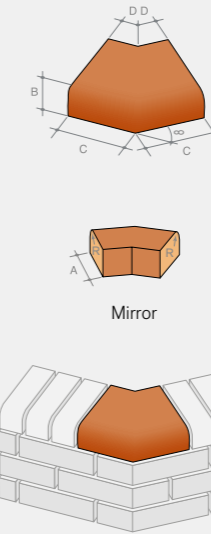

BN.20

External return to double bullnose - rounded corners on bed

To bullnose double header on flat or on edge.

Type	A	B	C	R
BN.20.1	215	215	102	25
BN.20.2	215	215	102	51
BN.20.3	215	215	65	25
BN.20.4	215	215	65	51

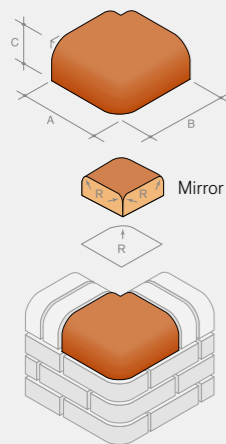

BN.21

Double bullnose - external angle to double bullnose

To bullnose double header on flat or on edge.

Type	A	B	C	D	R	∞
BN.21.1	215	102	159	101	25	30°
BN.21.2	215	102	159	101	51	30°
BN.21.3	215	65	159	101	25	30°
BN.21.4	215	65	159	101	51	30°
BN.21.5	215	102	159	70	25	45°
BN.21.6	215	102	159	70	51	45°
BN.21.7	215	65	159	70	25	45°
BN.21.8	215	65	159	70	51	45°
BN.21.9	215	102	159	35	25	60°
BN.21.10	215	102	159	35	51	60°
BN.21.11	215	65	159	35	25	60°
BN.21.12	215	65	159	35	51	60°

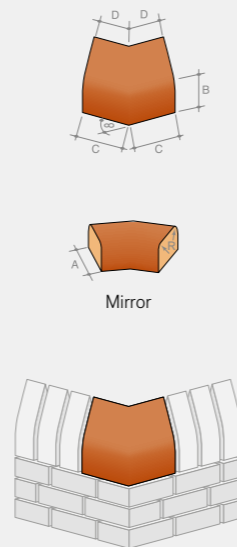

BN.23

Single bullnose internal angle to single bullnose

To bullnose single header on flat or on edge.

Type	A	B	C	D	R	∞
BN.23.1	215	102	159	101	25	30°
BN.23.2	215	102	159	101	51	30°
BN.23.3	215	65	159	101	25	30°
BN.23.4	215	65	159	101	51	30°
BN.23.5	215	102	159	70	25	45°
BN.23.6	215	102	159	70	51	45°
BN.23.7	215	65	159	70	25	45°
BN.23.8	215	65	159	70	51	45°
BN.23.9	215	102	159	35	25	60°
BN.23.10	215	102	159	35	51	60°
BN.23.11	215	65	159	35	25	60°
BN.23.12	215	65	159	35	51	60°

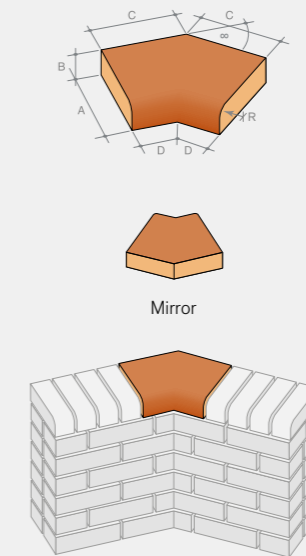

BN.24

Soldier bullnose external return

To bullnose double header on flat or on edge.

Type	A	B	C	R
BN.24.1	102	102	215	25
BN.24.2	102	102	215	51

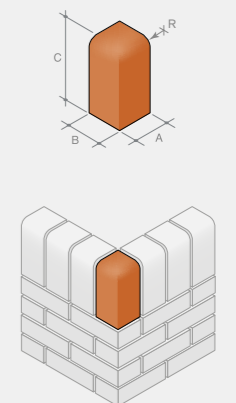

Pistol Bricks

This product is used to maintain brick coursing where shelf angles are introduced, creating external returns for brick slip cladding systems and creating brick clad lintels and soffit returns when adhered to structural support elements.



PS.1 Pistol soldier

Type	A	B	C	D	E
PS.1.1	215	102	65	140	25
PS.1.2	215	102	65	65	25
PS.1.3	215	102	65	185	25

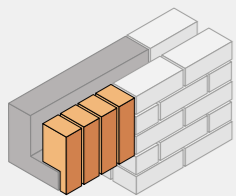
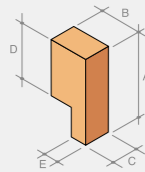

PS.2 Pistol stretcher

Left or right hand - if surface has textured finish.

Type	A	B	C	D	E
PS.2.1	215	102	65	35	20

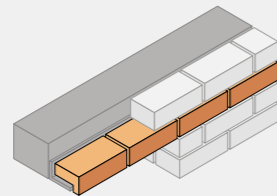
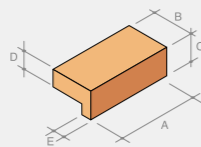

Soldier Bricks

The use of soldier bricks gives opportunities to break up mass and add interest to large areas of brickwork, in complementary or contrasting colours and textures.



SD.1 Soldier return

Type	A	B	C
SD.1.1	215	65	65
SD.1.2	215	102	102

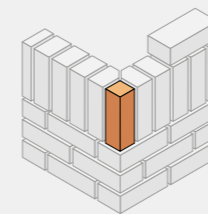
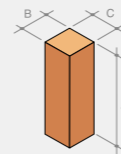

SD.2 Internal soldier return to single cant on end

Type	A	B	C	D	E
SD.2.1	215	102	102	46	159
SD.2.2	215	102	102	60	173

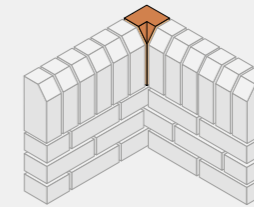
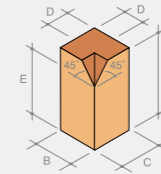

SD.3 External soldier return to single cant on end

Type	A	B	C	D	E
SD.3.1	215	102	102	46	159
SD.3.2	215	102	102	60	173

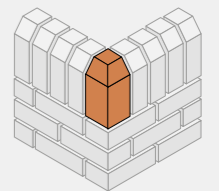
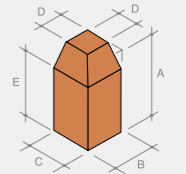

Plinth Bricks

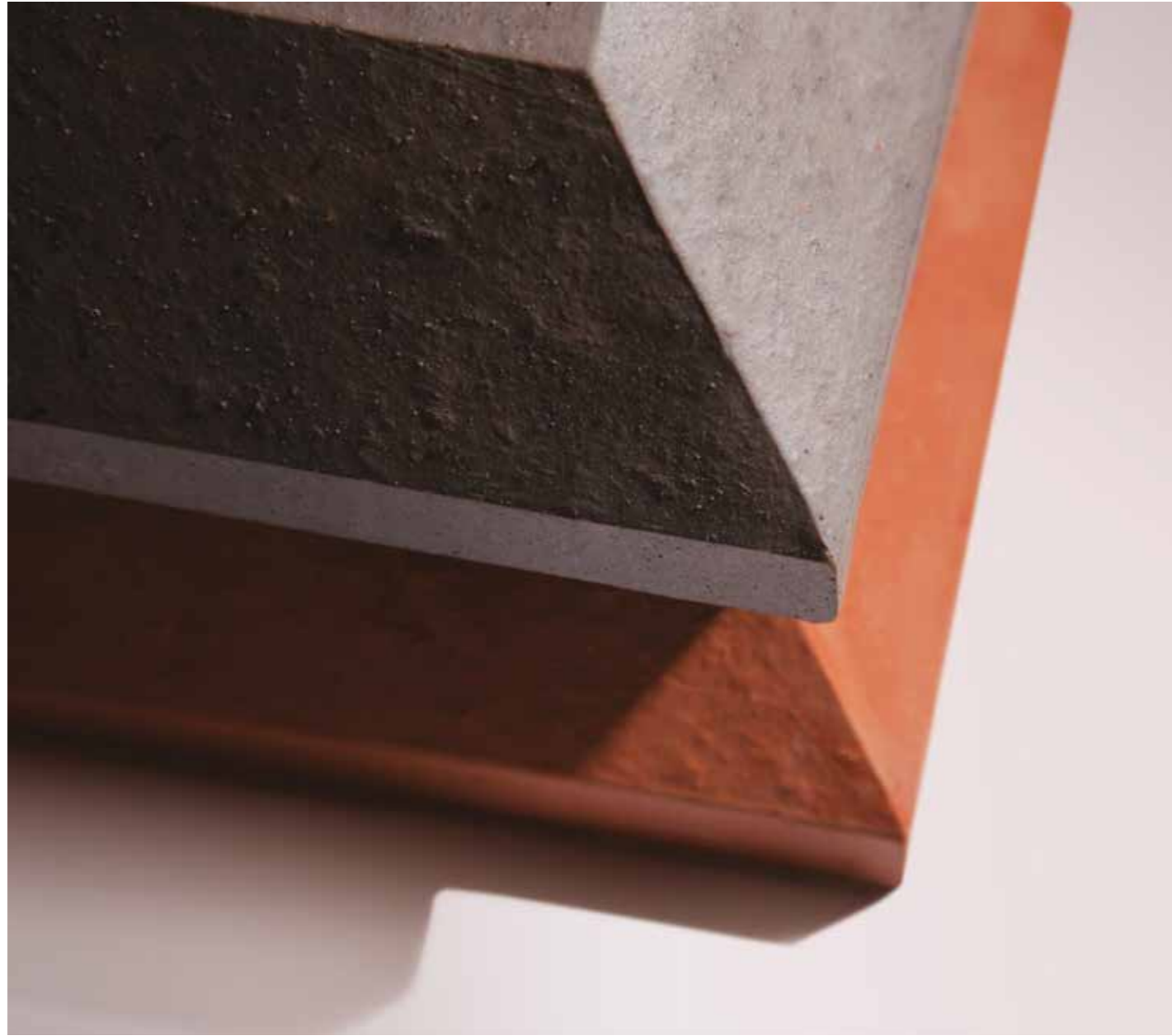

Plinth specials are often used to create a splay detail at the base of a building. They are also increasingly being used for corbel detailing and window surround details in association with angle and cant specials.

PL.1
Plinth stop or cant stop

Left or right hand.

Type	A	B	C	D	E	F	∞
PL.1.1	215	102	65	9	159	46	45°
PL.1.2	215	102	65	23	173	60	45°

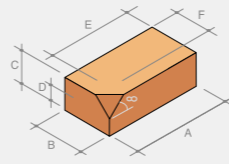

Left hand shown

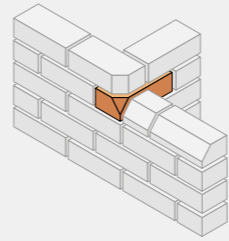

PL.2
Plinth header

Type	A	B	C	D	E	∞
PL.2.1	215	102	65	9	159	45°
PL.2.2	215	102	65	23	173	45°

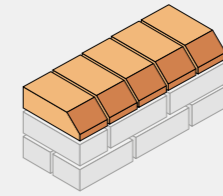
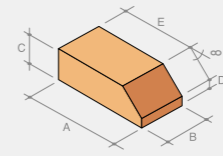

PL.3
Plinth stretcher

Type	A	B	C	D	E	∞
PL.3.1	215	102	65	9	46	45°
PL.3.2	215	102	65	23	60	45°

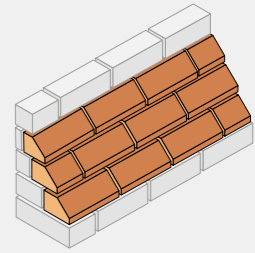
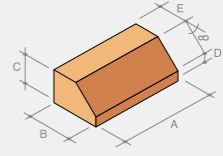

PL.3.1.1
Widebed plinth stretcher

Type	A	B	C	D	E	∞
PL.3.1.1	215	158	65	9	102	45°

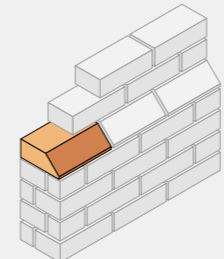
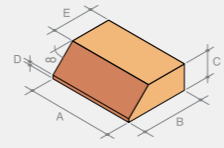

PL.3.2.1
Widebed plinth stretcher

Type	A	B	C	D	E	∞
PL.3.2.1	215	148	65	23	102	45°

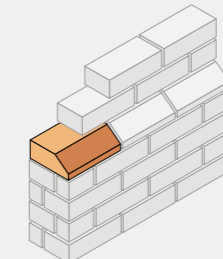
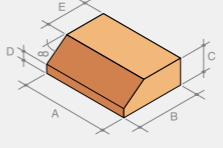

PL.4
Plinth internal return - long

Left or right hand.

Type	A	B	C	D	E	F	∞
PL.4.1	215	102	65	9	46	169	45°
PL.4.2	215	102	65	23	60	155	45°

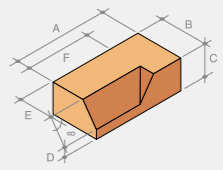

Left hand shown

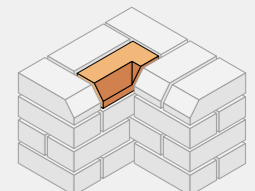

Plinth Bricks



PL.4.1.1
Widebed plinth internal return

Left or right hand.

Type	A	B	C	D	E	F	∞
PL.4.1.1	215	158	65	9	102	113	45°

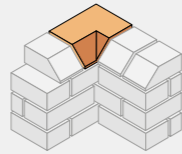
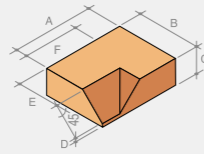

PL.4.2.1
Widebed plinth internal return

Left or right hand.

Type	A	B	C	D	E	F	∞
PL.4.2.1	215	148	65	23	102	113	45°

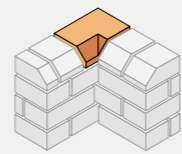
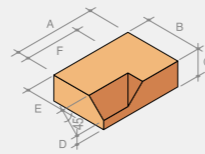

PL.7
Plinth external return

Left or right hand.

Type	A	B	C	D	E	F	∞
PL.7.1	215	102	65	9	159	46	45°
PL.7.2	215	102	65	23	173	60	45°

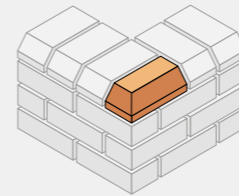
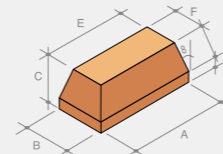

PL.7.1.1
Widebed plinth external return

Left or right hand.

Type	A	B	C	D	E	F	∞
PL.7.1.1	215	158	65	9	159	102	45°

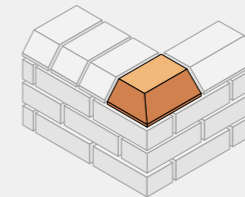
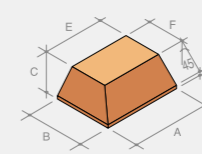

PL.7.2.1
Widebed plinth external return

Left or right hand.

Type	A	B	C	D	E	F	∞
PL.7.2.1	215	148	65	23	159	102	45°

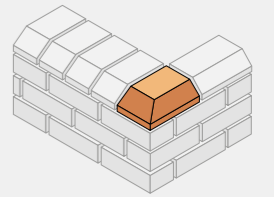
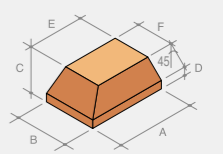

PL.5
Plinth internal return - short

Left or right hand.

Type	A	B	C	D	E	F	∞
PL.5.1	215	102	65	9	159	46	45°
PL.5.2	215	102	65	23	173	60	45°

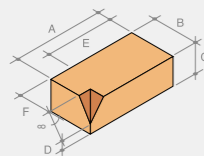

Left hand shown

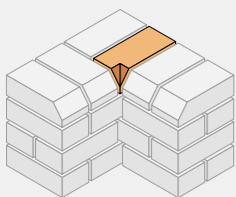

PL.6
Plinth internal angle

Left or right hand.

Type	A	B	C	D	E	F	∞
PL.6.1	164 ¹	102	65	9	51	46	30°
PL.6.2	164 ¹	102	65	23	51	60	30°
PL.6.3	164 ¹	102	65	9	51	46	45°
PL.6.4	164 ¹	102	65	23	51	60	45°
PL.6.5	164 ¹	102	65	9	51	46	60°
PL.6.6	164 ¹	102	65	23	51	60	60°
PL.6.7	159 ²	102	65	9	102	46	30°
PL.6.8	159 ²	102	65	23	102	60	30°
PL.6.9	159 ²	102	65	9	102	46	45°
PL.6.10	159 ²	102	65	23	102	60	45°
PL.6.11	159 ²	102	65	9	102	46	60°
PL.6.12	159 ²	102	65	23	102	60	60°
PL.6.13	215 ¹	102	65	9	102	46	30°
PL.6.14	215 ¹	102	65	23	102	60	30°
PL.6.15	215 ¹	102	65	9	102	46	45°
PL.6.16	215 ¹	102	65	23	102	60	45°
PL.6.17	215 ¹	102	65	9	102	46	60°
PL.6.18	215 ¹	102	65	23	102	60	60°

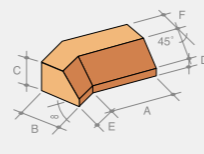

Left hand shown

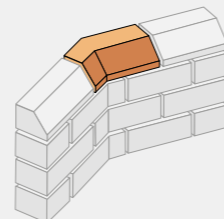

PL.8
Plinth external angle

Left or right hand.

Type	A	B	C	D	E	F	∞
PL.8.1	159 ²	102	65	9	102	46	30°
PL.8.2	159 ²	102	65	23	102	60	30°
PL.8.3	159 ²	102	65	9	102	46	45°
PL.8.4	159 ²	102	65	23	102	60	45°
PL.8.5	159 ²	102	65	9	102	46	60°
PL.8.6	159 ²	102	65	23	102	60	60°
PL.8.7	215 ¹	102	65	9	102	46	30°
PL.8.8	215 ¹	102	65	23	102	60	30°
PL.8.9	215 ¹	102	65	9	102	46	45°
PL.8.10	215 ¹	102	65	23	102	60	45°
PL.8.11	215 ¹	102	65	9	102	46	60°
PL.8.12	215 ¹	102	65	23	102	60	60°

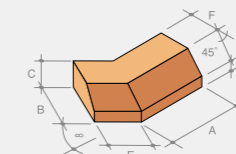

Left hand shown

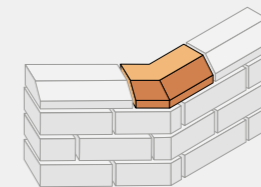

PL.9
Plinth external squint

Left or right hand.

Type	A	B	C	D	E	F	∞
PL.9.1	164	102	65	9	51	46	30°
PL.9.2	164	102	65	23	51	60	30°
PL.9.3	164	102	65	9	51	46	45°
PL.9.4	164	102	65	23	51	60	45°
PL.9.5	164	102	65	9	51	46	60°
PL.9.6	164	102	65	23	51	60	60°

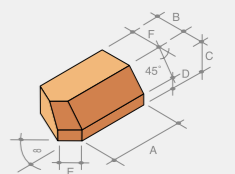

Left hand shown

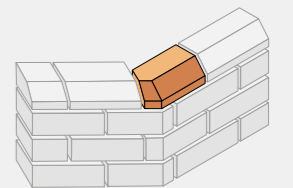

¹ Suitable for half bond without cutting.
² Suitable for quarter bond without cutting.

¹ Suitable for half bond without cutting.
² Suitable for quarter bond without cutting.

Radial Bricks

Radial specials are primarily used to form circular detail brickwork in plan, without having tapered joints. They also give a true, concise curve to brickwork.



RD.1 Radial header

Type	A	B	C	D	¹	²
RD.1.1	215	108	65	52	450	6
RD.1.2	215	108	65	70	675	9
RD.1.3	215	108	65	80	900	12
RD.1.4	215	108	65	89	1350	18
RD.1.5	215	108	65	97	2250	30
RD.1.6	215	108	65	103	5400	72

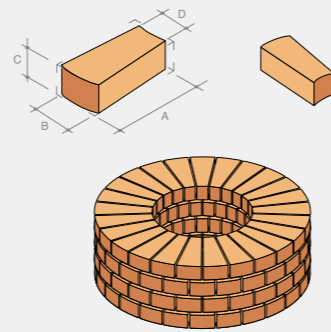

¹ Ideal outer radius (mm).
² No. per quadrant.
 Dimensions B and D in types RD.1 are segmented lengths, measured from corner to corner, not along curve.

RD.2 Radial stretcher

Type	A	B	C	D	¹	²
RD.2.1	226	102	65	172	450	3
RD.2.2	226	102	65	190	675	4.5
RD.2.3	226	102	65	199	900	6
RD.2.4	226	102	65	208	1350	9
RD.2.5	226	102	65	215	2250	15
RD.2.6	226	102	65	221	5400	36

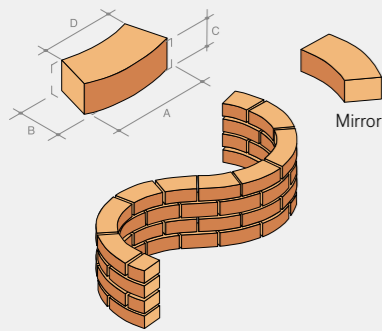

¹ Ideal outer radius (mm).
² No. per quadrant.
 Dimensions A and D in types RD.2 are segmented lengths, measured from corner to corner, not along curve.

RD.3 Radial stretcher

Type	A*	B	C	R1
RD.3.1	215	102	65	250
RD.3.2	215	102	65	500
RD.3.3	215	102	65	750
RD.3.4	215	102	65	1000
RD.3.5	215	102	65	1250

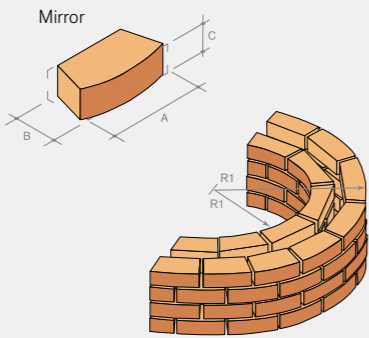

* Denotes chord length.

RD.4 Radial stretcher

Type	A*	B	C	R1
RD.4.1	215	102	65	250
RD.4.2	215	102	65	500
RD.4.3	215	102	65	750
RD.4.4	215	102	65	1000

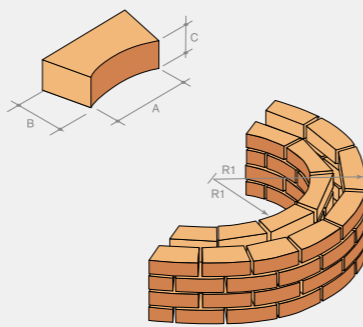

* Denotes chord length.

Arch Bricks & Systems



Arch or tapered bricks are used to form semi-circular, bullseye, segmental or other forms of decorative arch units to several different radii specified in the standard.

Our pre-packaged arch sets make the construction of traditional voussoir-style window and door arches simple and accurate.

Although purpose made specials have always been available, they have, in the past, only been produced to order. This is especially true of arches.

We have now enhanced this facility by manufacturing a wide choice of classic arch sets that can usually be delivered direct to site within three weeks from acceptance of order.

Arch Bricks & Systems

AR.1 Tapered header

Type	A	B	C	D	¹	²	³
AR.1.1	215	102	75	59	910	12	20/21
AR.1.2	215	102	75	64	1360	18	28/29
AR.1.3	215	102	75	66	1810	30	36/37
AR.1.4	215	102	75	69	2710	72	53/54

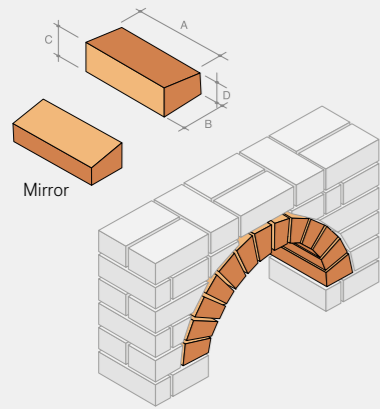

¹ Ideal span (mm).
² No. of whole bricks.
³ Bricks in semi-circle.

AR.2 Tapered stretcher

Type	A	B	C	D	¹	²	³
AR.2.1	215	102	75	48	910	4	25
AR.2.2	215	102	75	55	1360	6	33
AR.2.3	215	102	75	58	1810	8	41
AR.2.4	215	102	75	63	2710	12	58

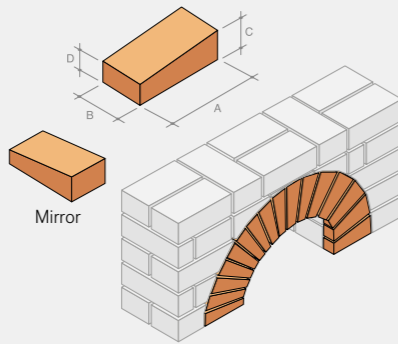

¹ Ideal span (mm).
² No. of whole bricks.
³ Bricks in semi-circle.
This format is not as versatile in applications as AR.1 series because the longer voussoir joint accentuates splays. Tolerance allowances limit versatility further.

KS.1, KS.2, KS.3 Keystones - to suit any size span

Type	A ¹	B ²	C	D ³
U143	10	215	102	125
U77	30	215	102	140
U144	70	215	102	185
U79	100	215	102	215
U78	130	215	102	240
U80	140	215	102	250

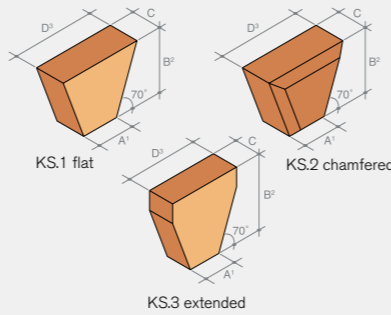

KS.3 B² dimension = 290mm.
Keystones are sized to suit the particular span requirements. Dimension A¹ and D³ will change according to the span.
For further clarification regarding dimensions of brick units please contact our sales staff.

Arch Bricks & Systems

Curved Arch

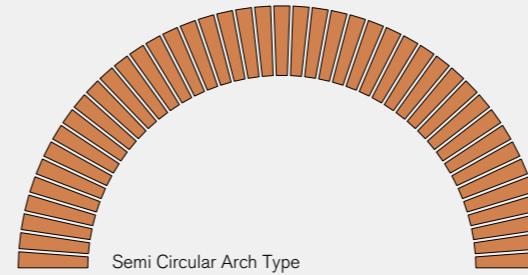

Semi Circular Arch Type

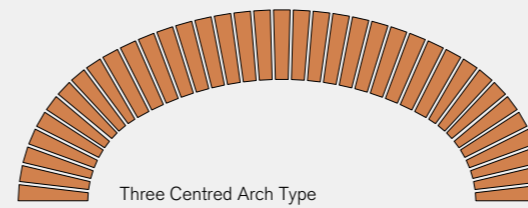

Three Centred Arch Type

Dim 0 - window opening.
Dim B - keystone.
¹ No. of standard units.

Note: All arches are available as individual bricks or pre-cast units.

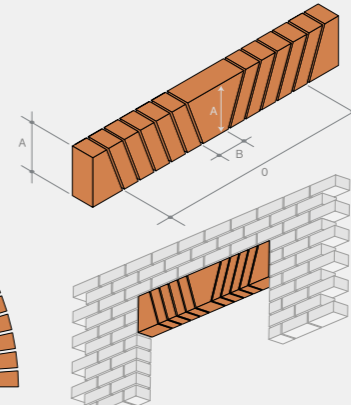

Dim 0	Dim B	A	¹
488	18	215	6
630	10	215	8
915	145	215	10
1200	130	215	14
1500	130	215	18
1750	80	215	22
1800	130	215	22
2250	130	215	28
2350	80	215	30
2400	130	215	30

MAR.1 Tapered single cant

Type	A	B	C	D	E	F	¹
MAR.1.1	215	102	75	33	159	46	450
MAR.1.2	215	102	75	33	173	60	450
MAR.1.3	215	102	75	51	159	46	1125
MAR.1.4	215	102	75	51	173	60	1125
MAR.1.5	215	102	75	42	159	46	675
MAR.1.6	215	102	75	42	173	60	675
MAR.1.7	215	102	75	60	159	46	2025
MAR.1.8	215	102	75	60	173	60	2025

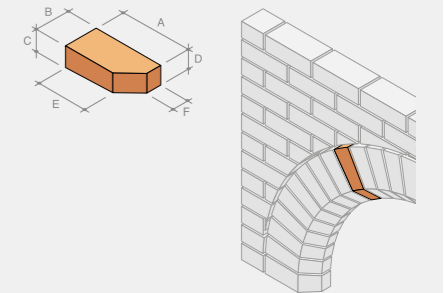

¹ Ideal span (mm).
Other sizes are also available.

Pre-fabricated Arches

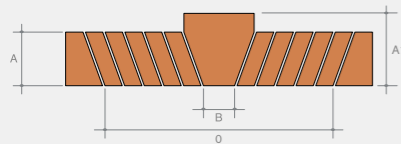

For dimensions of pre-fabricated arches see chart opposite. Other sizes can also be manufactured as required.

Arch Types Available



Flat Gauged Arch Type

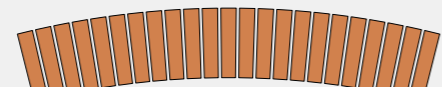

Segmental Arch Type

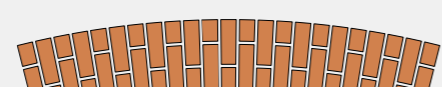

Segmental Arch Type

Dim 0 - window opening.
Dim B - keystone.
¹ No. of standard units.

All arches are available as individual bricks or pre-cast units.

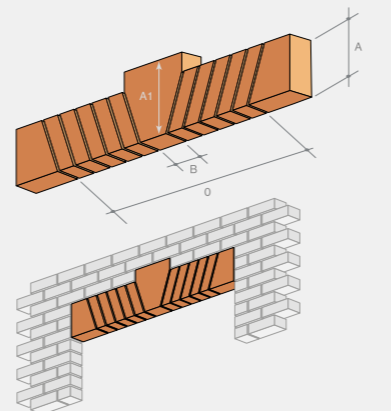

Dim 0	Dim B	A	A ¹	¹
488	18	215	290	6
630	10	215	290	8
915	145	215	290	10
1200	130	215	290	14
1500	130	215	290	18
1750	80	215	290	22
1800	130	215	290	22
2250	130	215	290	28
2350	80	215	290	30
2400	130	215	290	30

MAR.2 Tapered single bullnose

Type	A	B	C	D	R	¹
MAR.2.1	215	102	75	33	25	450
MAR.2.2	215	102	75	33	51	450
MAR.2.3	215	102	75	51	25	1125
MAR.2.4	215	102	75	51	51	1125
MAR.2.5	215	102	75	42	25	675
MAR.2.6	215	102	75	42	51	675
MAR.2.7	215	102	75	60	25	2025
MAR.2.8	215	102	75	60	51	2025

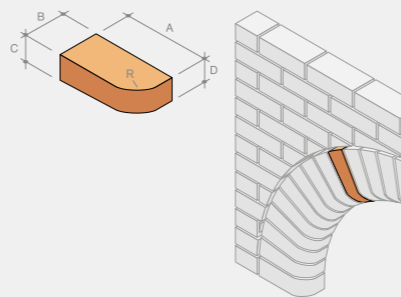

¹ Ideal span (mm).
Other sizes are also available.

MAR.3 Flat arch voussoir

Left or right hand.

Type	A	B	C	¹
MAR.3	215	102	65	75 ¹

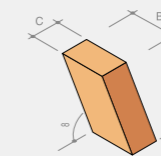

Left hand shown

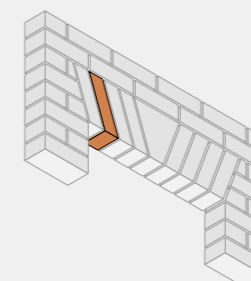

Curved Arch

Dim 0	A	¹
915	215	17
1500	215	24
1800	215	26
2250	215	31

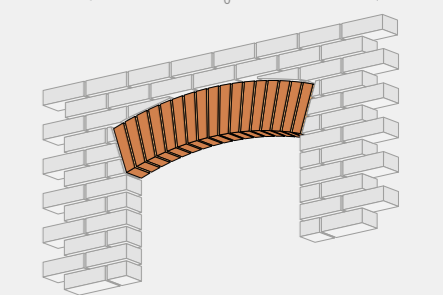
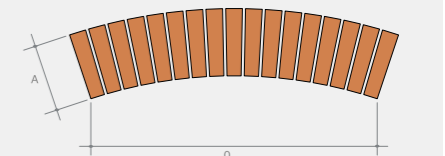

Dim 0 - window opening, ¹ No. of standard units.
Guideline for number of units required.
Window openings up to 1800mm use tapered bricks. All arches are available as individual bricks or pre-cast units.

Non Standard Brick Specials

Cradley produce a wide range of bespoke architectural brick specials, to help create unique brickwork features and detailing.

Cills

Copings & Cappings

Slips & Spacing Bricks

Renovation Specials & Restoration

Large Format Pier Caps

Bat & Swift Boxes

Imperial Size Bricks

Cut & Bond Bricks

Clay Pavers



Cills

Our range of cills and returns have been designed to provide the correct overhang and drip detail to ensure durability of brickwork.



CS.1 Cill brick

Type	A	B	C	D	E
CS.1.1	140	140	65	50	50
CS.1.2	140	140	65	65	65
CS.1.3	150	140	65	65	65
CS.1.4	170	140	65	50	80
CS.1.9	150	140	65	50	55
CS.1.10	190	140	65	65	65

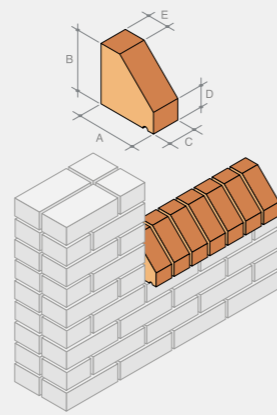

CS.2 Cill external return

Type	A	B	C	D	E
CS.2.1.1	140	140	65	35	15
CS.2.2.1	150	140	65	36	15
CS.2.3.1	150	140	65	40	15
CS.2.11.1	190	140	65	50	15

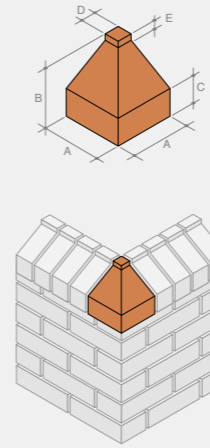

CS.2 Cill internal return

Type	A	B	C	D	E
CS.2.1.2	140	140	65	35	15
CS.2.2.2	150	140	65	36	15
CS.2.3.2	150	140	65	40	15
CS.2.4.2	190	140	65	50	15

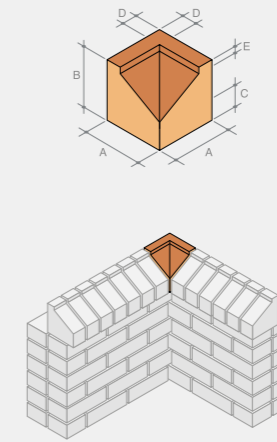

CS.535 Cill block

Type	A	B	C1	C2
CS.535.1	215	185	65	51

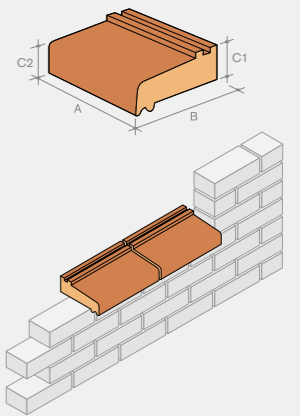

CS.1 Cill external return

Type	A	B	C	D
CS.1.1.1	140	140	50	50
CS.1.2.1	140	140	65	65
CS.1.3.1	150	140	65	65
CS.1.4.1	170	140	50	80
CS.1.9.1	150	140	50	55
CS.1.10.1	190	140	65	65

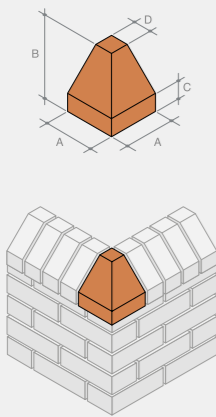

CS.1 Cill internal return

Type	A	B	C	D
CS.1.1.2	140	140	50	50
CS.1.2.2	140	140	65	65
CS.1.3.2	150	140	65	65
CS.1.4.2	170	140	50	80
CS.1.9.2	150	140	50	55
CS.1.10.2	190	140	65	65

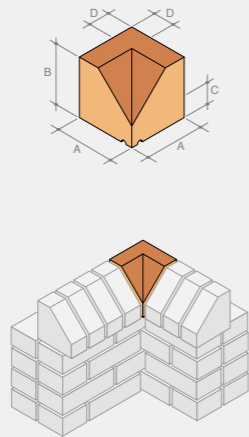

CS.2 Cill brick

Type	A	B	C	D	E	F
CS.2.1	140	140	65	35	15	65
CS.2.2	150	140	65	36	15	65
CS.2.3	150	140	65	40	15	65
CS.2.4	190	140	65	50	15	65

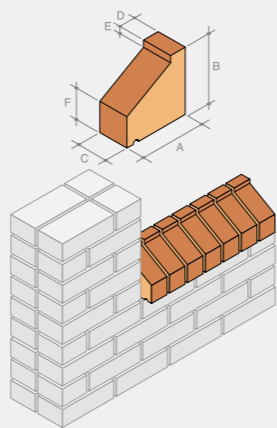

Creasing Tile Cill

Also available in bespoke sizes.



CRADLEY

SPECIAL BRICK

a Forterra brand

Cill Tile Creasing brick

Type	AB	CD	EF
U6804	70 170	140 70	24 56

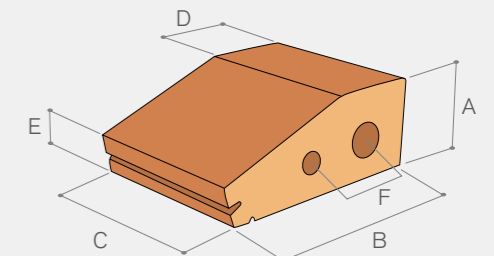

Copings & Cappings



Coping and capping bricks are used to cap the tops of parapet or free standing walls and are available in two sizes.

Coping - 305mm wide with drips for use as an overhanging coping on a 215mm wide wall.

Capping - 215mm wide when used as a capping.

We can also supply non-standard sized copings and cappings to suit all project requirements. Returns, stop ends and angles to these specials are available to complement the set.

CP.1.1
Half round coping

Type	A	B	C	D1	D2
CP.1.1	305	153	65	13	15

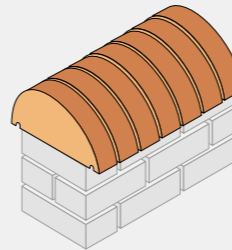
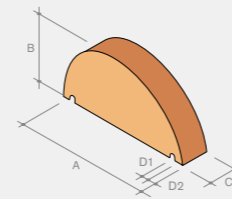

When these copings are required at stop-end locations, specially faced units can be provided.

CP.1.1.1
Half round coping stop end

Type	A	B	C	D1	D2
CP.1.1.1	305	153	204	13	15

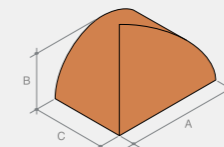

Mirror

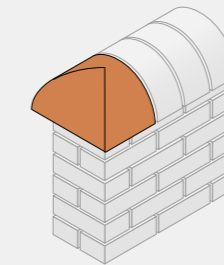

CP.1.1.2
Half round coping return

Type	A	B	D1	D2
CP.1.1.2	305	153	13	15

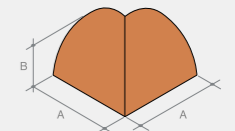

Mirror

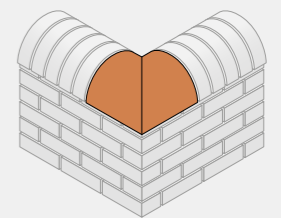

CP.1.1.3
Half round coping T junction

Type	A	B	D1	D2
CP.1.1.3	305	153	13	15

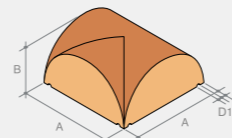

Mirror

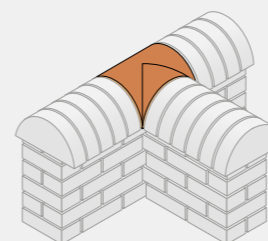

CP.1.2
Half round capping

Type	A	B	C
CP.1.2	215	108	65

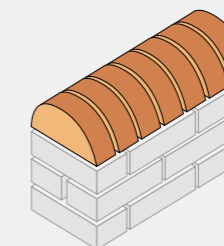
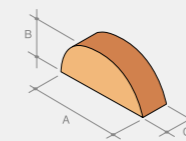

When these cappings are required at stop-end locations, specially faced units can be provided.

CP.1.2.1
Half round capping stop end

Type	A	B	C
CP.1.2.1	215	108	159

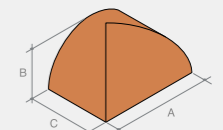

Mirror

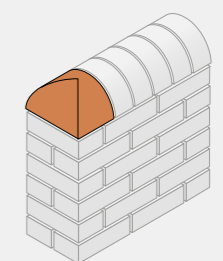

Copings & Cappings



CP.2.1.1
Saddleback coping stop end

Type	A	B	C	D	D1	D2
CP.2.1.1	305	153	204	50	13	15

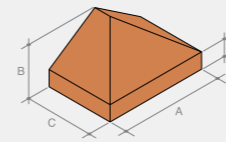

Mirror

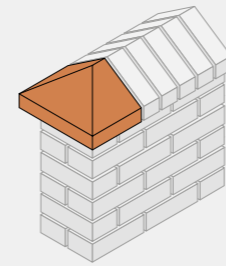

CP.2.1.2
Saddleback coping return

Type	A	B	C	D1	D2
CP.2.1.2	305	153	50	13	15

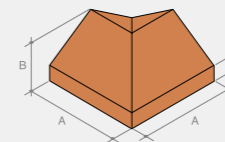

Mirror

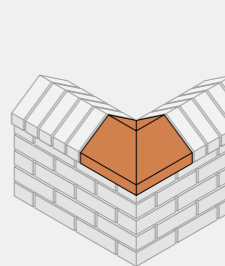

CP.2.1.3
Saddleback coping T junction

Type	A	B	C	D1	D2
CP.2.1.3	305	153	50	13	15

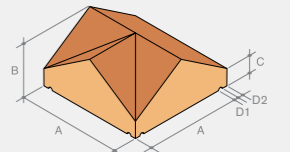

Mirror

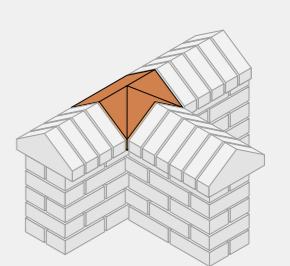

CP.1.2.2
Half round capping return

Type	A	B
CP.1.2.2	215	108

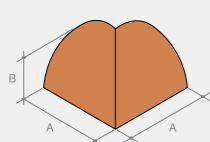

Mirror

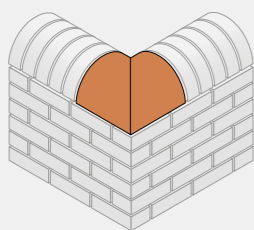

CP.1.2.3
Half round capping T junction

Type	A	B
CP.1.2.3	215	108

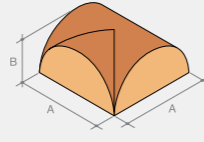

Mirror

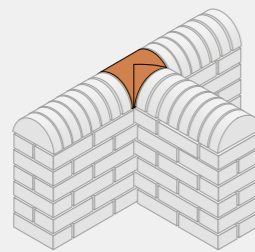

CP.2.1
Saddleback coping

Type	A	B	C	D1	D2	E
CP.2.1	305	153	65	13	15	50

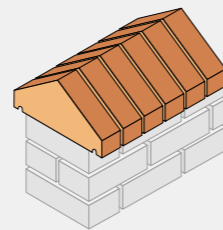
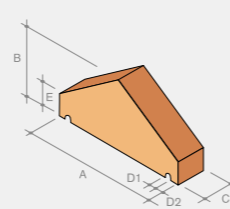

When these copings are required at stop-end locations, specially faced units can be provided.

CP.2.2
Saddleback capping

Type	A	B	C	D
CP.2.2	215	123	65	50

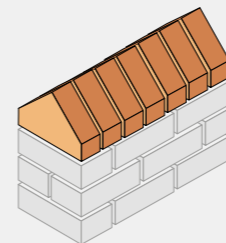
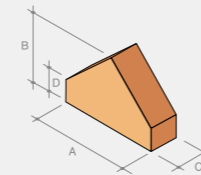

When these cappings are required at stop-end locations, specially faced units can be provided.

CP.2.2.1
Saddleback capping stop end

Type	A	B	C	D
CP.2.2.1	215	123	159	50

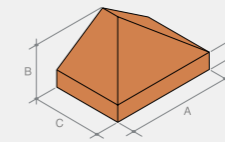

Mirror

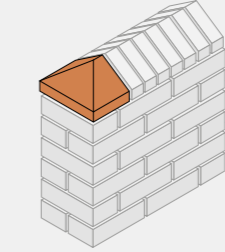

CP.2.2.2
Saddleback capping return

Type	A	B	C
CP.2.2.2	215	123	50

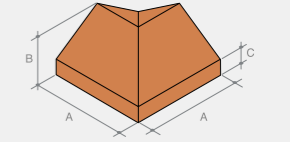

Mirror

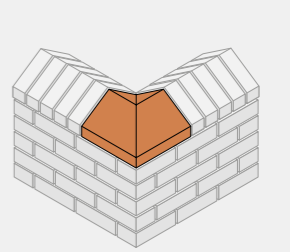

Copings & Cappings

CP.2.2.3 Saddleback capping T junction

Type	A	B	C
CP.2.2.3	215	123	50

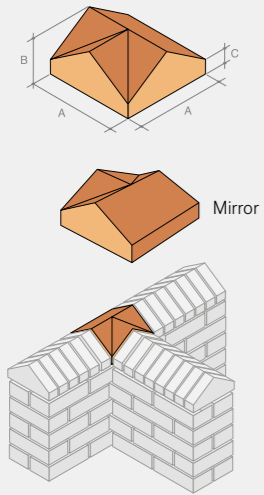

CWC.1 Wave coping

Type	A	B	C
CWC.1	282	128	215

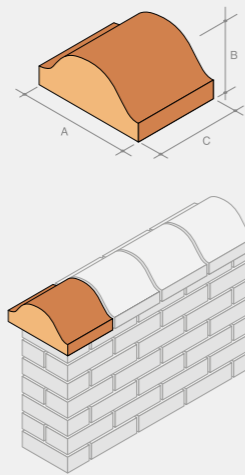

Also see restoration and renovation section.

CWC.2 Wave coping stop end

Type	A	B	C
CWC.2	282	128	215

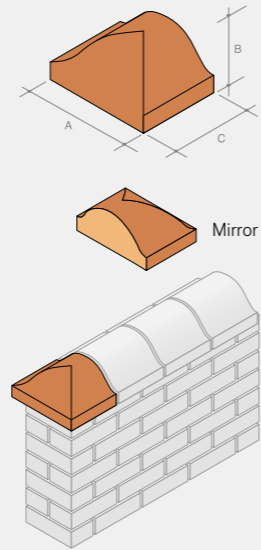

Also see restoration and renovation section.

PC.2 Bullnose pier cap

Type	A	B	C	R
PC.2.1	215	215	102	25
PC.2.2	215	215	102	51
PC.2.3	215	215	65	25
PC.2.4	215	215	65	51

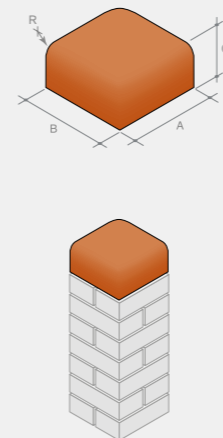

PC.500 Pier cap 229 x 229mm

Type	A	B	C
PC.500	229	229	56

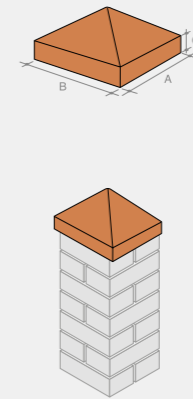

PC.501 Pier cap 440 x 440mm

Type	A	B	C
PC.501	440	440	85

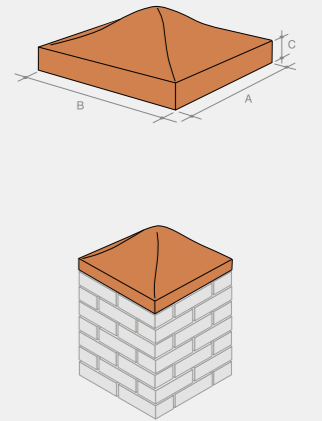

Red only Redbank.

CWC.3 Wave coping return

Type	A	B	C
CWC.3	282	128	282

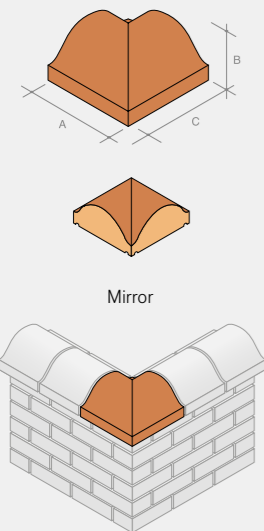

Also see restoration and renovation section.

PC.1 Canted pier cap

Type	A	B	C	D	E
PC.1.1	215	215	102	46	103
PC.1.2	215	215	102	60	131
PC.1.3	215	215	65	9	103
PC.1.4	215	215	65	23	131

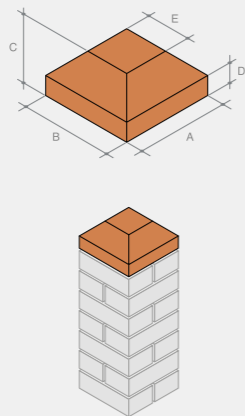

Also see angle and cant section.



PC.502 Pier cap 440 x 440mm

Type	A	B	C
PC.502	440	440	115

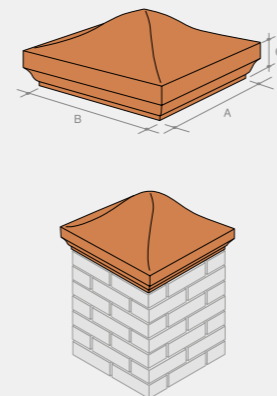

Red only Redbank.

PC.503 Pier cap 521 x 521mm

Type	A	B	C
PC.503	521	521	80

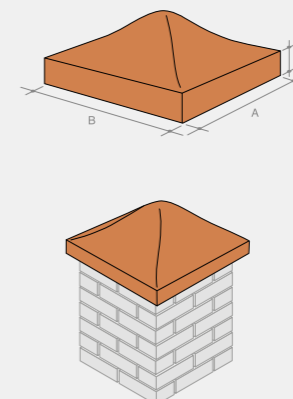

Red only Redbank.

PC.504 Pier cap 305 x 305mm

Type	A	B	C
PC.504	305	305	80

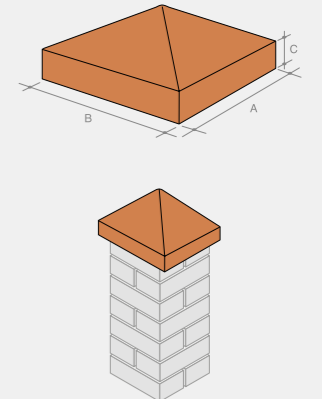

Copings & Cappings



U425
Small apex pier cap

Type	A	B	C	D
U.425	305	305	153	50

PC.505
Pier cap 521 x 521mm

Type	A	B	C
PC.505	521	521	115

Red only Redbank.

PC.506
Pier cap 300 x 300mm

Type	A	B	C
PC.506	300	300	65

U426
Medium apex pier cap

Type	A	B	C	D
U.426	400	400	170	65



Non Standard Brick Specials

Slips & Spacing Bricks

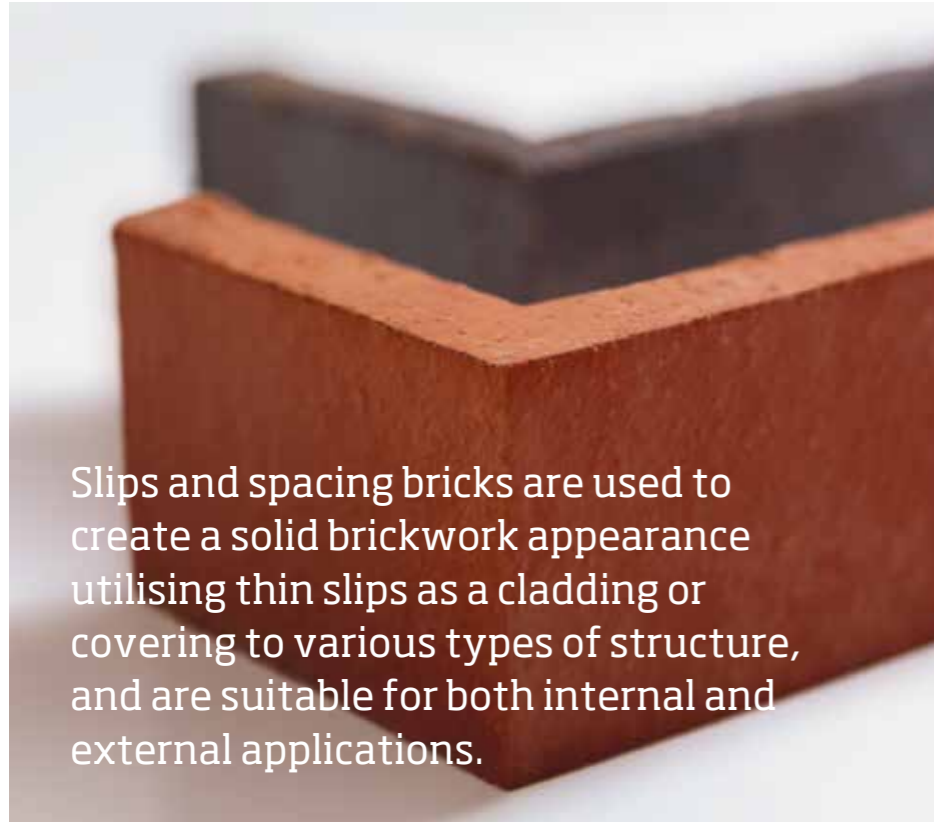

Slips and spacing bricks are used to create a solid brickwork appearance utilising thin slips as a cladding or covering to various types of structure, and are suitable for both internal and external applications.

SL Brick face slip			
Type	A	B	C
SL.20	215	20	65
SL.25	215	25	65
SL.30	215	30	65
SL.40	215	40	65
SL.50	215	50	65

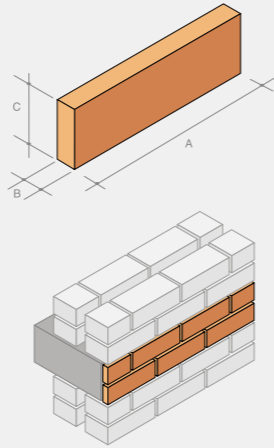

SL.2 Brick bed slip			
Type	A	B	C
SL.2	215	102	25

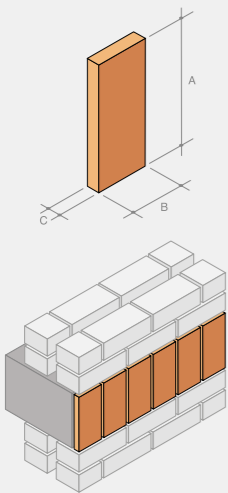

SLR Slip return				
Type	A	B	C	D
SLR.20	215	65	102	25
SLR.25	215	65	102	25
SLR.30	215	65	102	30
SLR.40	215	65	102	40

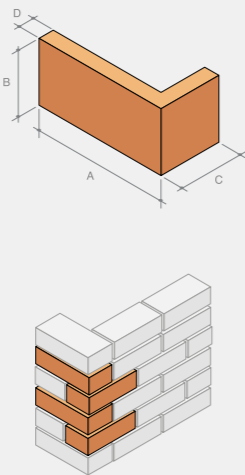

SP Spacing bricks			
Manhole spacing/packing brick.			
Type	A	B	C
SP.1	215	102	20
SP.2	215	102	30
SP.3	215	102	40

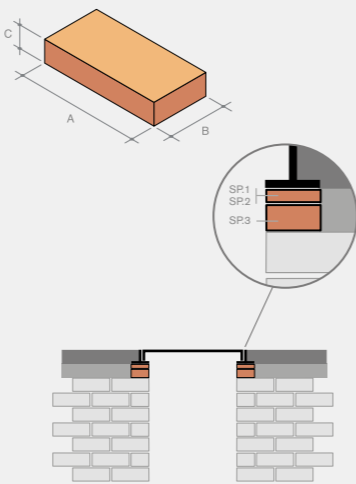

CRADLEY
SPECIAL BRICK
a Forterra brand

ORDER YOUR SPACING BRICKS NOW!

Ex-stock of 20, 30 & 40mm Cradley Spacing Bricks for next day delivery.



Don't forget to add Thermalite Trenchblocks and Class B Engineering Bricks to your order.

SPACING BRICK PACK SIZES AVAILABLE:

SP.1 - 20MM - QTY 800PK

SP.2 - 30MM - QTY 800PK

SP.3 - 40MM - QTY 500PK

Renovation Specials & Restoration



Special shaped bricks are often called upon to re-create the distinctive architectural features associated with traditional buildings and help in the upkeep and maintenance of our national heritage buildings.

Based around our British Standard and purpose made specials range, we manufacture an extensive range of special shaped bricks to complement even the most complex refurbishment project.

Imperial Bricks

In addition to our standard range of bricks, we offer a full range of imperial sized bricks at 215 x 102.5 x 73mm. Imperial sized bricks are ideal for extensions and refurbishment projects.



MRN.1 Plinth roll stretcher

Type	A	B	C	D
MRN.1	215	140	65	102

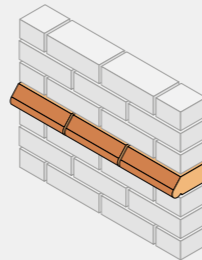
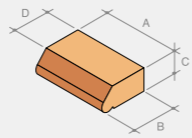

Other depths are also available.

MRN.2 Plinth roll internal return

Left or right hand.

Type	A	B	C	D	E	F	G
MRN.2	261	215	65	102	140	75	121

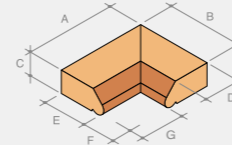

Right hand shown

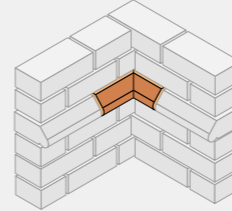

Other depths are also available.

MRN.3 Plinth roll external return

Left or right hand.

Type	A	B	C	D	E
MRN.3	253	140	65	215	102

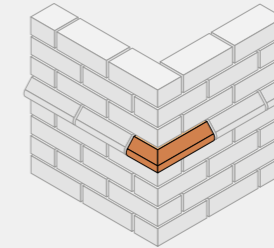
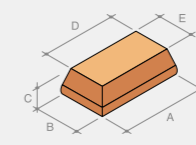

Other depths are also available.

MRN.4 Roll stretcher

Type	A	B	C	D	R
MRN.4	215	163	65	130	33

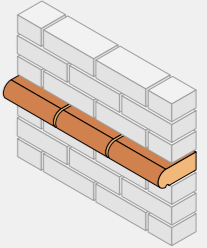
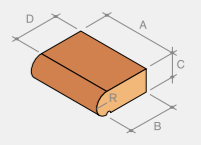

Other depths are also available.

MRN.5 Roll internal return

Left or right hand.

Type	A	B	C	D	E	F	G
MRN.5	261	215	65	130	163	52	98

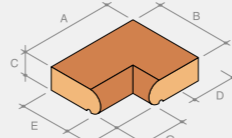

Right hand shown

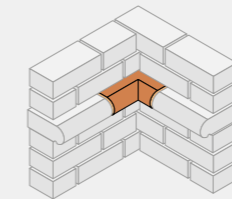

Other depths are also available.

MRN.6 Roll external return

Left or right hand.

Type	A	B	C	D	E
MRN.6	276	163	65	243	130

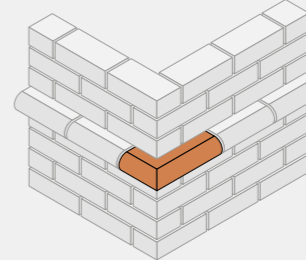
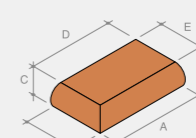

Other depths are also available.

MRN.7 Ogee stretcher

Type	A	B	C
MRN.7	215	145	65

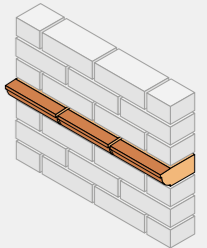
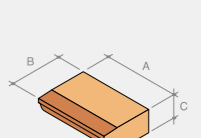

Other depths are also available.

Renovation Specials & Restoration



MRN.8
Ogee internal return

Left or right hand.

Type	A	B	C	D
MRN.8	261	215	65	145

Other depths are also available.

MRN.9
Ogee external return

Left or right hand.

Type	A	B	C
MRN.9	258	145	65

Left hand shown

Other depths are also available.

MRN.10
Ogee stretcher

Type	A	B	C
MRN.10	215	137	65

Other depths are also available.

MRN.11
Ogee internal return

Left or right hand.

Type	A	B	C	D
MRN.11	261	215	137	65

Right hand shown

Other depths are also available.

MRN.12
Ogee external return

Left or right hand.

Type	A	B	C
MRN.12	250	137	65

Left hand shown

Other depths are also available.

MRN.13
Half diamond stretcher

Type	A	B	C
MRN.13	215	102	65

Other depths are also available.

MRN.14
Half diamond header

Type	A	B	C
MRN.14	215	102	65

Other depths are also available.

MRN.15
Half diamond external return

Left or right hand.

Type	A	B	C
MRN.15	215	102	65

Other depths are also available.

MRN.16
Star stretcher

Left or right hand.

Type	A	B	C
MRN.16	215	102	65

Other depths are also available.

Renovation Specials & Restoration



MRN.17
Diamond stretcher

Type	A	B	C
MRN.17	215	102	65

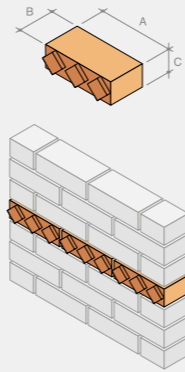

Other depths are also available.

MRN.21
Corbel pedestal external return

Type	A	B	C	D
MRN.21	140	150	102	102

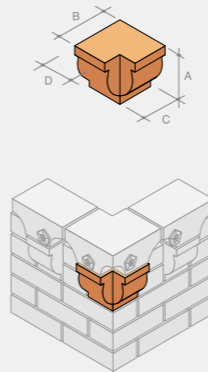

Other depths are also available.

MRN.22
Corbel rose capping external return

Type	A	B	C	D	E
MRN.22	215	150	102	46	102

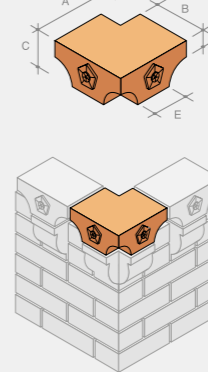

Other depths are also available.



MRN.18
Pyramid stretcher

Type	A	B	C
MRN.18	215	102	65

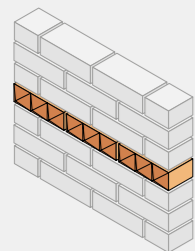
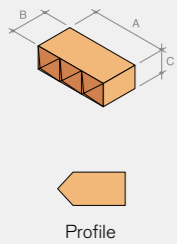

Other depths are also available.

MRN.19
Corbel pedestal

Type	A	B	C	D
MRN.19	140	150	102	102

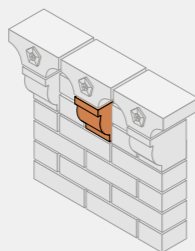
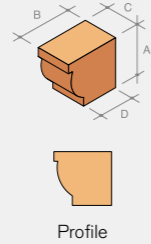

Other depths are also available.

MRN.20
Corbel rose capping

Type	A	B	C	D	E	F
MRN.20	215	150	102	46	102	102

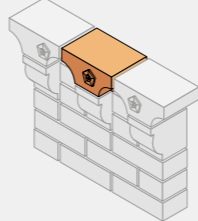
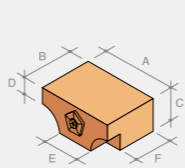

MRN.23
Flower stretcher

Type	A	B	C
MRN.23	215	102	102

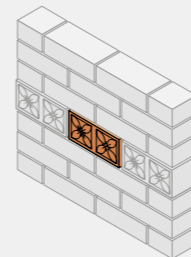
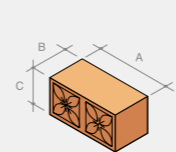

Other depths are also available.

MRN.24
Flower internal return

Type	A	B	C
MRN.24	215	102	102

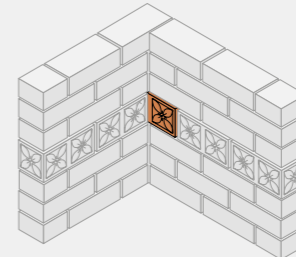
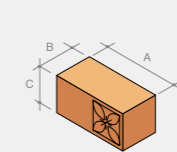

Other depths are also available.

MRN.25
Flower external return

Type	A	B	C
MRN.25	215	102	65

Left or right hand.

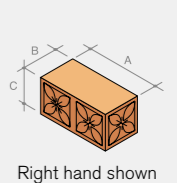

Right hand shown

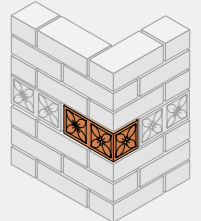

Other depths are also available.

Renovation Specials & Restoration



MRN.29
Single bullnose stop

Left or right hand.

Type	A	B	C	D
MRN.29	215	102	65	10

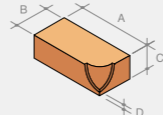

Profile

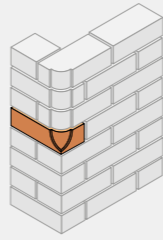

Other depths are also available.

CWC.1
Wave coping

Type	A	B	C
CWC.1	282	128	215

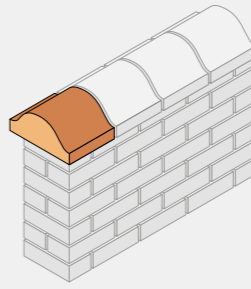
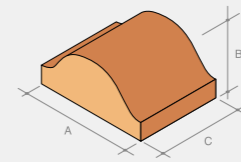

Also see copings and cappings section.

CWC.2
Wave coping stop end

Type	A	B	C
CWC.2	282	128	215

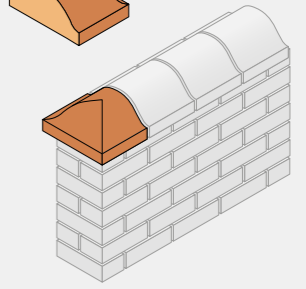
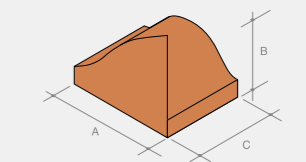

Also see copings and cappings section.

MRN.26
Feature quoin stretcher

Left or right hand.

Type	A	B	C	D	E
MRN.26	215	102	65	165	52

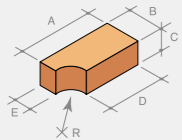

Right hand shown

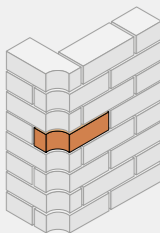

Other depths are also available.

MRN.27
Feature quoin stop

Left or right hand.

Type	A	B	C	D
MRN.27	215	102	65	15

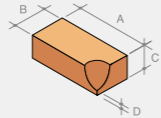

Right hand shown

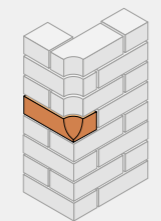

Other depths are also available.

MRN.28
Single bullnose

Left or right hand.

Type	A	B	C	D	E
MRN.28	215	102	65	160	47

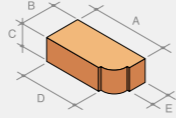

Left hand shown

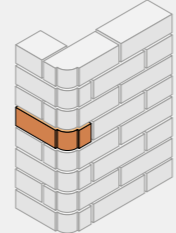

Other depths are also available.

CWC.3
Wave coping return

Type	A	B	C
CWC.3	282	128	282

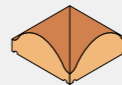
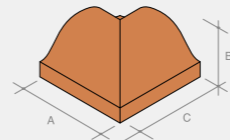

Rear view

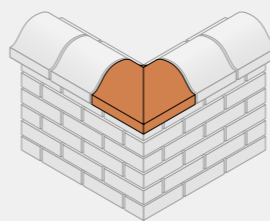

Also see copings and cappings section.

List No. 762
Regency string course

Type	A	B	C
762	215	102.5	65

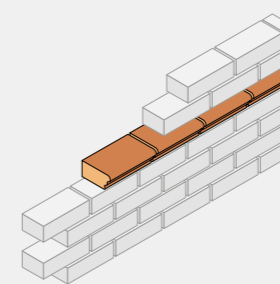
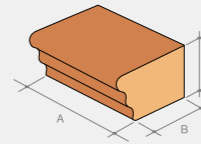

Other lengths are also available.

List No. 768
Victorian string course

Type	A	B	C
768	215	112.5	150

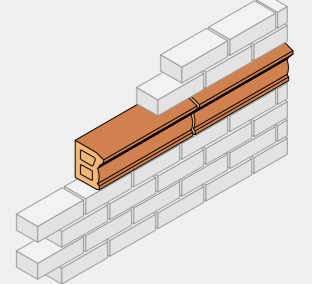
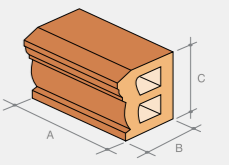

Other lengths are also available.

Renovation Specials & Restoration

List No. 870 Decorative Bricks

Type	A	B	C
870	65	65	
870	140	140	100
870	300	300	



List No. 870-TR
Tudor Rose



List No. 870-LF
Leaf



List No. 870-FL
Flower



List No. 870-CL
Curved Leaf



List No. 870-FC
Four Curve



List No. 870-CR
Celtic Cross



List No. 870-PL
Plain



List No. 870-WL
Wheel



Personalised & Date Bricks

Made to customer specification



Large Format Pier Caps



Cradley manufacture some of the largest extruded bricks in the UK.

Ideal for restoration, refurbishment and new build projects, this range emulates the Victorian preference for large section brickwork, which was used to cap walls and pillars and on major civil engineering projects such as canals built in the late 1800s, and later railways.

Size Comparison

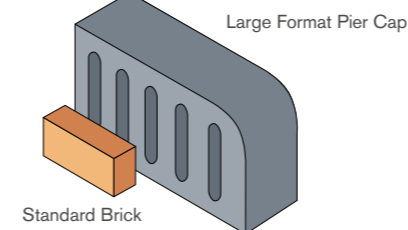

Bat & Swift Boxes



Bats need a range of roosting sites, including summer daytime roosts, winter hibernation ones and breeding sites.

Boxes can be positioned high on buildings which avoids the threat from predators. Some species of bat prefer roosts at least five metres off the ground, and therefore a good position is under the eaves to protect them from bad weather.

Swifts have been in decline, because modern buildings have fewer holes for them to nest in.

'Built in' is the best way to create new nest places for Swifts, ensuring longevity, safety and minimal maintenance. There are a variety of ways to do this and a Swift box is a simple way of neatly incorporating a nest box into any new building.

BB.290
Bat box

Type	A	B	C	D	E	F
BB.290	215	102.5	290	9	215	65

BB.140
Bat box

Type	A	B	C	D	E	F
BB.140	215	102.5	140	9	65	65

SB.140
Swift box

Type	A	B	C	D	E	F	G
SB.140	328	200	140	65	33	152	24

Cut & Bond Bricks



Cut and bond specials are epoxy bonded which makes them suitable for both internal and external applications where angled special shaped bricks would normally be employed.

For those occasions when construction deadlines are tight, or something other than standard specials are required, Cradley can provide a cut and bond service, under the strict control of the Company's quality assurance system. Cut and bond specials provide an economical alternative to many standard specials with the added bonus of greatly reduced lead times.

Cut & Bond Brick

Cut Brick

Bonding Bricks

BD.1.1 Half Bat/Snap Header

BD.1.2 Three Quarter Bat

BD.2 King Closer

BD.3 Queen Closer

Angle & Cant Bricks

AN.1 Squint

AN.1.1, AN.1.2, AN.1.3

AN.2 External Angle

AN.2.1, AN.2.2, AN.2.3, AN.2.4, AN.2.5, AN.2.6

AN.3 Internal Angle/Dog Leg

AN.3.1, AN.3.2, AN.3.3, AN.3.4, AN.3.5, AN.3.6, AN.3.7, AN.3.8, AN.3.9

AN.5 Single Cant

AN.5.1, AN.5.2

AN.6 Double Cant

AN.6.1, AN.6.2

Plinth Bricks

PL.2.2 Plinth Header

PL.3.2 Plinth Stretcher

PL.3.2.1 Widebed Plinth Stretcher

PL.4.2 Plinth Internal Return - Long

PL.4.2.1 Widebed Plinth Internal Return

PL.6 Plinth Internal Angle

PL.6.2, PL.6.4, PL.6.6, PL.6.8, PL.6.10, PL.6.12, PL.6.14, PL.6.16, PL.6.18

PL.7.2 Plinth External Return

PL.8 Plinth External Angle

PL.8.2, PL.8.4, PL.8.6, PL.8.8, PL.8.10, PL.8.12

PL.9 Plinth External Squint

PL.9.2, PL.9.4, PL.9.6

Brick Slips

SL Brick Slip

SL.20, SL.25, SL.30, SL.40, SL.50

SLR Slip Return

SLR.20, SLR.25, SLR.30, SLR.40, SLR.50

Pistol Bricks

PS.1 Pistol Soldier

PS.1.1, PS.1.2, PS.1.3

PS.2 Pistol Stretcher

PS.2.1

Clay Pavers



The quality and aesthetic appeal of clay pavers is of paramount importance to the success of any hard landscaping.

With years of experience in the manufacture of clay pavers, Cradley has the knowledge required to produce the right product to the highest standards.

The colours of our clay pavers are derived from either a single clay or a controlled blend of clays, combined with compounds and special firing techniques, to provide a fully fired and non fading product of the highest quality.

BK.1
Boot kerb

Type	A	B	C	D	E	R
BK.1	100	200	125	60	103	50

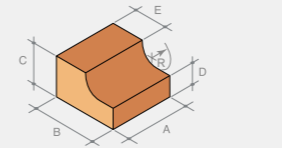

PF.1
Half paver

Type	A	B	C
PF.1	97	97	60

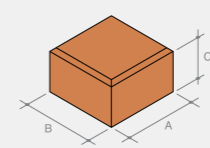

PF.2
Small triangle

Type	A	B	C	D
PF.2	97	97	60	137

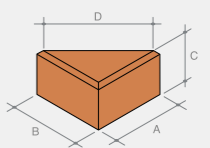

PF.3
Bishop mitre

Type	A	B	C	D	E
PF.3	197	197	60	280	25

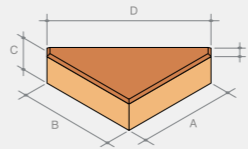

PF.4
Square block

Type	A	B	C
PF.4	197	197	60

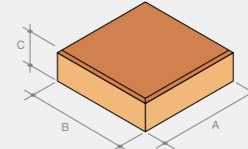

PF.5
Edge trimmer

Type	A	B	C	D
PF.5	294	97	60	197

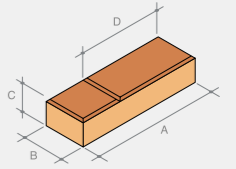

PF.6
Kerbline unit

Type	A	B	C	D	R	∞
PF.6	100	125	175	75	18	72°

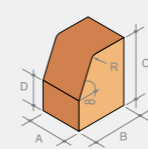

9.1 No. per linear metre.

PF.7
Kerbline internal return

Type	A	B	C	R	∞
PF.7	125	125	175	18	72°

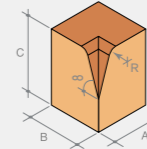

PF.8
Kerbline external return

Type	A	B	C	R	∞
PF.8	125	125	175	18	72°

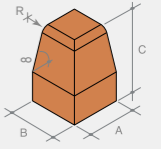

PF.9
Kerbline flush kerb

Type	A	B	C
PF.9	100	125	75

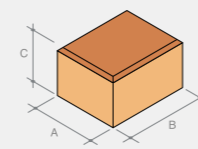

9.1 No. per linear metre.

PF.10
Kerbline transition set

Type	A	B	C	D	E	R	∞
PF.10	900	125	175	75	293	18	72°

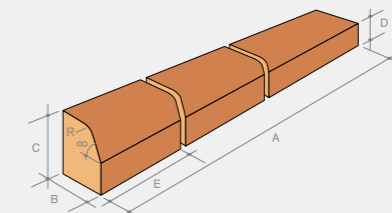

PF.11
Bullnose kerb

Type	A	B	C	R
PF.11.1	65	103	215	25
PF.11.2	65	103	215	51

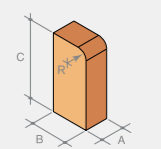

Clay Pavers



PF.12
Bullnose kerb internal return

Type	A	B	C	R
PF.12.1 ¹	103	103	215	25
PF.12.2 ²	103	103	215	51

¹ To suit PF 11.1 ² To suit PF 11.2.

PF.13
Bullnose kerb external return

Type	A	B	C	R
PF.13.1 ¹	103	103	215	25
PF.13.2 ²	103	103	215	51

¹ To suit PF 11.1 ² To suit PF 11.2.

PF.14
Cant kerb

Type	A	B	C	D	E
PF.14.1	65	103	215	46	159
PF.14.2	65	103	215	60	172

13.4 No. per linear metre.

PF.15
Cant kerb internal return

Type	A	B	C	D	E
PF.15.1 ¹	103	103	215	46	159
PF.15.2 ²	103	103	215	60	172

¹ To suit PF 14.1 ² To suit PF 14.2.

PF.16
Cant kerb external return

Type	A	B	C	D	E
PF.16.1 ¹	103	103	215	46	159
PF.16.2 ²	103	103	215	60	172

¹ To suit PF 14.1 ² To suit PF 14.2.

PF.17
Channel (smooth face)

Type	A	B	C	D	E
PF.17	200	100	60	20	10

9.1 No. per linear metre.

PF.18
Channel stop (smooth face)

Type	A	B	C	D	E
PF.18	200	200	60	20	10

Profile

PF.19
Channel return (smooth face)

Type	A	B	C	D	E
PF.19	200	200	60	20	10

Profile

PF.26
Step nosing stretcher

Type	A	B	C	R
PF.26	100	200	60	7

PF.27
Step nosing marker

Type	A	B	C	R
PF.27	200	100	60	7

PF.28
Step nosing corner

Type	A	B	C	R
PF.28	200	200	60	7

PF.29
Utility step paver

Type	A	B	C
PF.29	200	100	60

PF.30
Post/bollard surround

Type	A	B	C	D	E	R
PF.30	195	195	65	115	115	85

PF.31
Transkerb unit

Type	A	B	C	D	E
PF.31	160	100	125	65	100

9.1 No. per linear metre.

PF.32
Transkerb transitional unit

Left or right hand.

Type	A	B	C	D	E	F
PF.32	160	160	125	20	100	65

Right hand shown.

PF.33
Transkerb crossover unit

Type	A	B	C	D	E
PF.33	160	100	65	125	20

9.1 No. per linear metre.



Clay Pavers



PF.36.1
Ramp unit 1

Type	A	B	C	D
PF.36.1	200	100	60	90

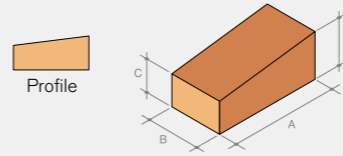

9.1 No. per linear metre. Designed to be used as a rigid construction detail.

PF.36.2
Ramp unit 2

Type	A	B	C	D
PF.36.2	200	100	91.5	116.5

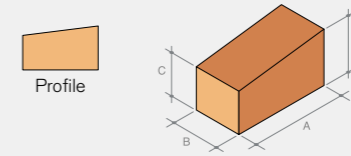

9.1 No. per linear metre. Designed to be used as a rigid construction detail.

PF.36.3
Ramp unit 3

Type	A	B	C	D	E
PF.36.3	200	100	117.5	140	20

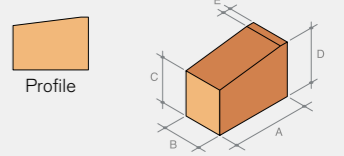

9.1 No. per linear metre. Designed to be used as a rigid construction detail.

PF.36.4
Ramp unit 4

Type	A	B	C	D	E
PF.36.4	200	100	60	140	20

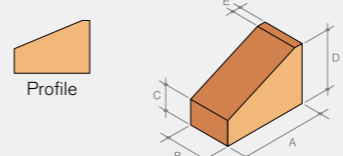

9.1 No. per linear metre. Designed to be used as a rigid construction detail.

PF.36.5
Ramp return

Left or right hand

Type	A	B	C	D	E
PF.36.5	200	200	60	140	90

Right hand shown

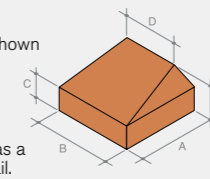

Designed to be used as a rigid construction detail.

PF.36.6
Ramp return

Left or right hand

Type	A	B	C	D	E	F	G
PF.36.6	200	200	91.5	137	77	60	116.5

Right hand shown

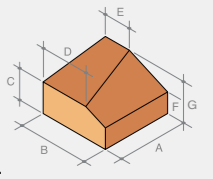

Designed to be used as a rigid construction detail.

PF.34
Transkerb internal return

Type	A	B	C	D
PF.34	160	160	125	60

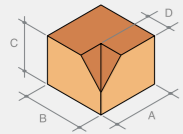

PF.36
Ramp set (complete)

Type	A	B	C	D	E
PF.36RS	620	100	60	140	20

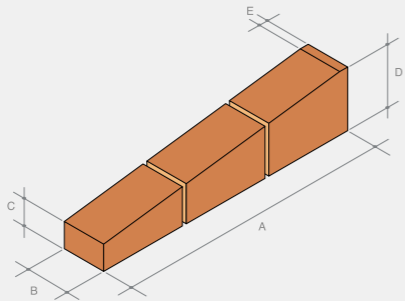

13.4 No. per linear metre. Designed to be used as a rigid construction detail.

PF.36
Ramp return

Left or right hand.

Type	A	B	C	D	E
PF.36RR	620	100	60	20	140

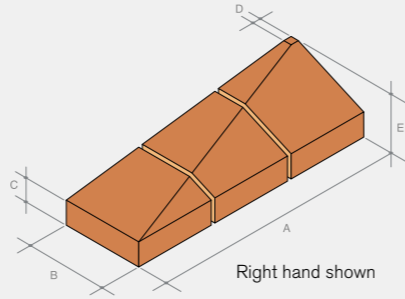

Designed to be used as a rigid construction detail.

PF.36.7
Ramp return

Left or right hand

Type	A	B	C	D	E	F	G
PF.36.7	200	200	117.5	74	20	60	140

Right hand shown

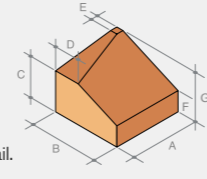

Designed to be used as a rigid construction detail.

PF.38
Tactile blister paver

Type	A	B	C
PF.38	200	133	60

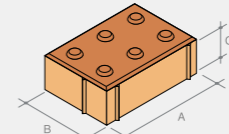

PF.35
Transkerb external return

Type	A	B	C	D	E
PF.35	160	160	65	100	125

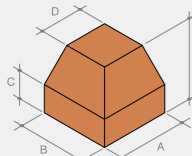

9.1 No. per linear metre.

PF.39
Tactile ribbed paver

Type	A	B	C
PF.39	200	160	60

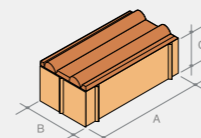

PF.40
Chocolate bar paver

Type	A	B	C
PF.40	200	100	60

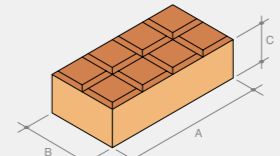

Decorative pavers are manufactured with a smooth finish.

DP
Diamond paver

Type	A	B	C
DP.1	200	100	50
DP.2	200	100	65
DP.3	300	150	50
DP.5	300	150	65

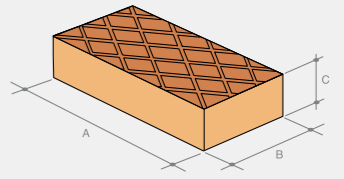

Decorative pavers are manufactured with a smooth finish.

Clay Pavers



PF.55
Tactile platform edge (lozenge) unit B

Type	A	B	C
PF55	200	133	60

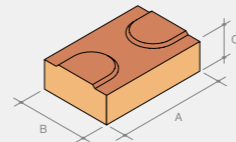

PF.56
Tactile platform edge (blister)

Type	A	B	C
PF56	200	133	60

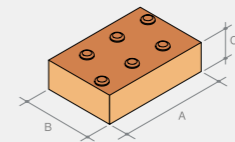

PF.60
Rumble strip

Type	A	B	C	D
PF36.5	200	110	60	80

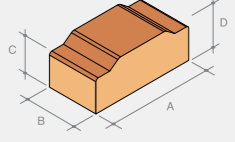

9.1 No. per linear metre. Designed to be used as a rigid construction detail.

PF.61
Rumble strip stop end

Type	A	B	C	D
PF61	200	200	60	80

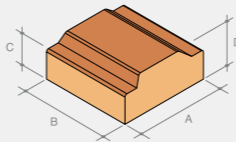

Designed to be used as a rigid construction detail.

PF.42
Stable block paver

Type	A	B	C
PF42	200	100	60

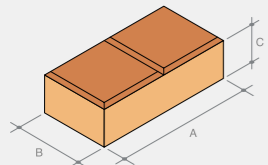

Decorative pavers are manufactured with a smooth finish.

PF.50
Tactile directional paver

Type	A	B	C
PF50	200	160	60

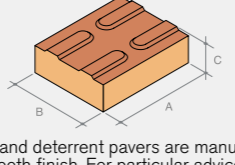

All tactile and deterrent pavers are manufactured with a smooth finish. For particular advice on the recommended use of these systems please contact our advisory services department.

PF.51
Tactile directional paver unit B

Type	A	B	C
PF51	200	100	60

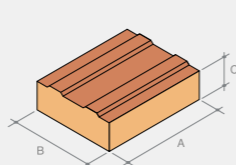

PF.52
Tactile directional paver unit C

Type	A	B	C
PF52	200	160	60

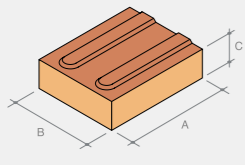

PF.53
Tactile cycleway paver

Type	A	B	C
PF53	200	80	60

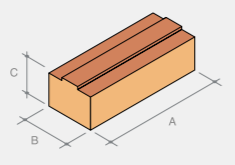

PF.54
Tactile platform edge (lozenge) unit A

Type	A	B	C
PF54	200	133	60

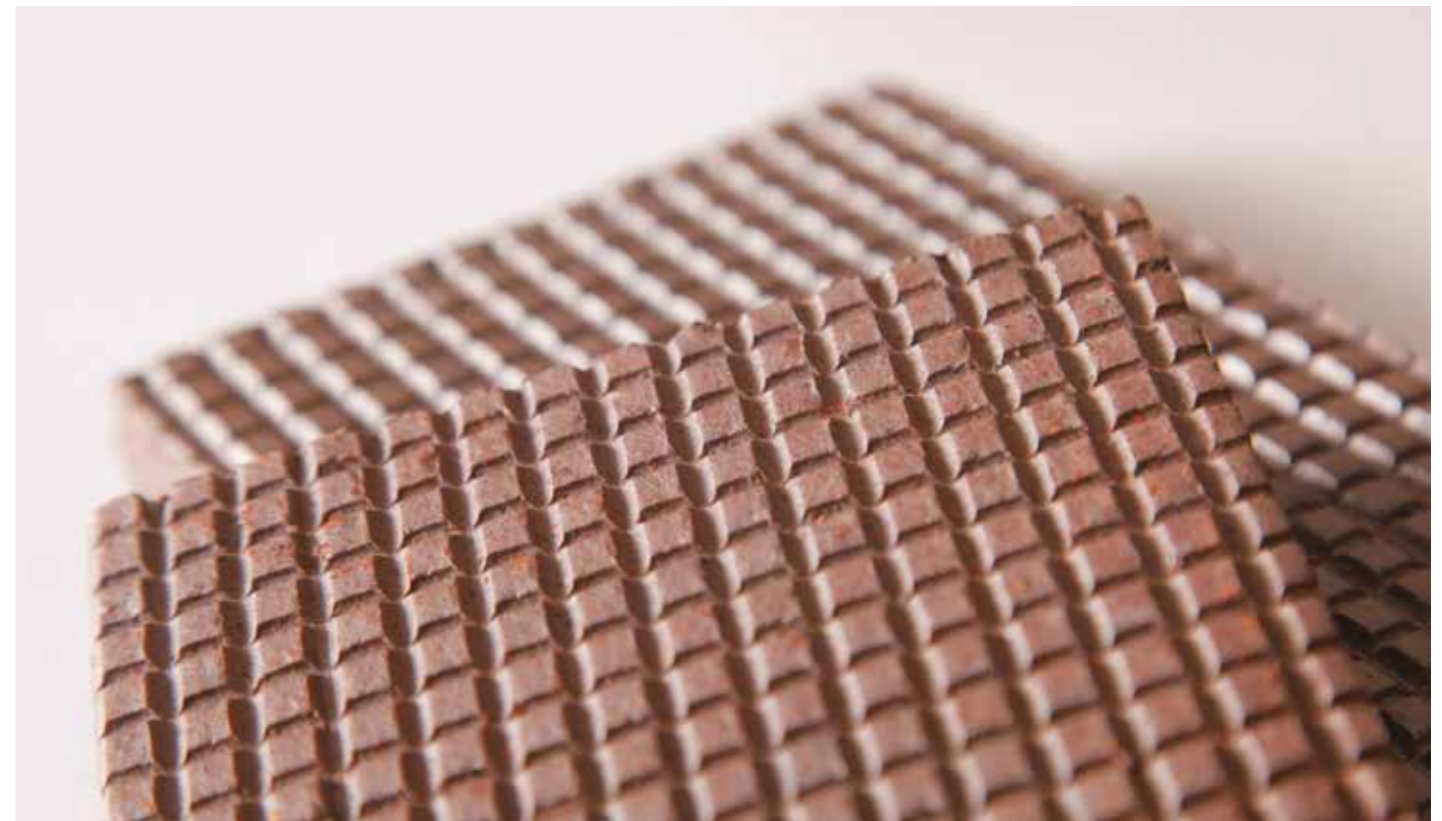
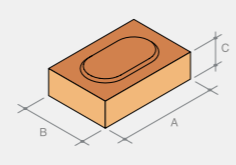

Frost Protection

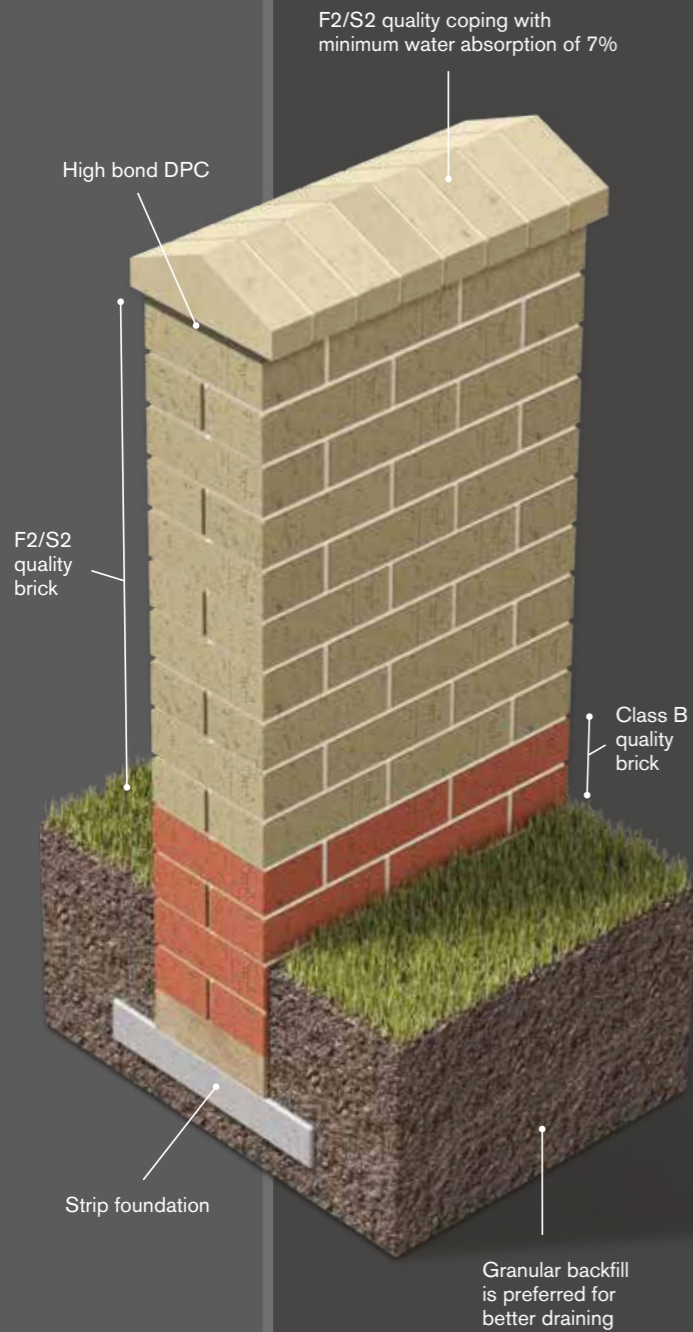

Freestanding Walls

Freestanding walls can be subjected to severe weather conditions. In order to minimise frost damage careful consideration must be paid to the following aspects of design:

Class B quality bricks should be used from foundation level to 150mm (minimum) above ground level (M12 mortar or 1:1/4:3). This will also act as a rigid DPC.

The main body of the wall should be constructed in "F2/S2" quality facing bricks (M6 mortar or 1:1/2:4 1/2).

All copings must be of "F2/S2" quality and have a water absorption not exceeding 7% (M12 mortar or 1:1/4:3).

We recommend that drip channels are introduced on all copings to shed rain clear of the wall face.

Drip channels should have sharp edges and be free from mortar or other obstruction.

Copings should overhang the wall face by at least 45mm.

"F1" quality bricks must not be used for the main body of the wall, cappings or copings on freestanding walls.

Mortar joints are not impervious to moisture. This is resolved by using a high bond continuous damp proof membrane immediately below the copings, projecting at least 13mm beyond the mortar.

A flexible DPC should be avoided at all times as this will reduce overall structural stability.

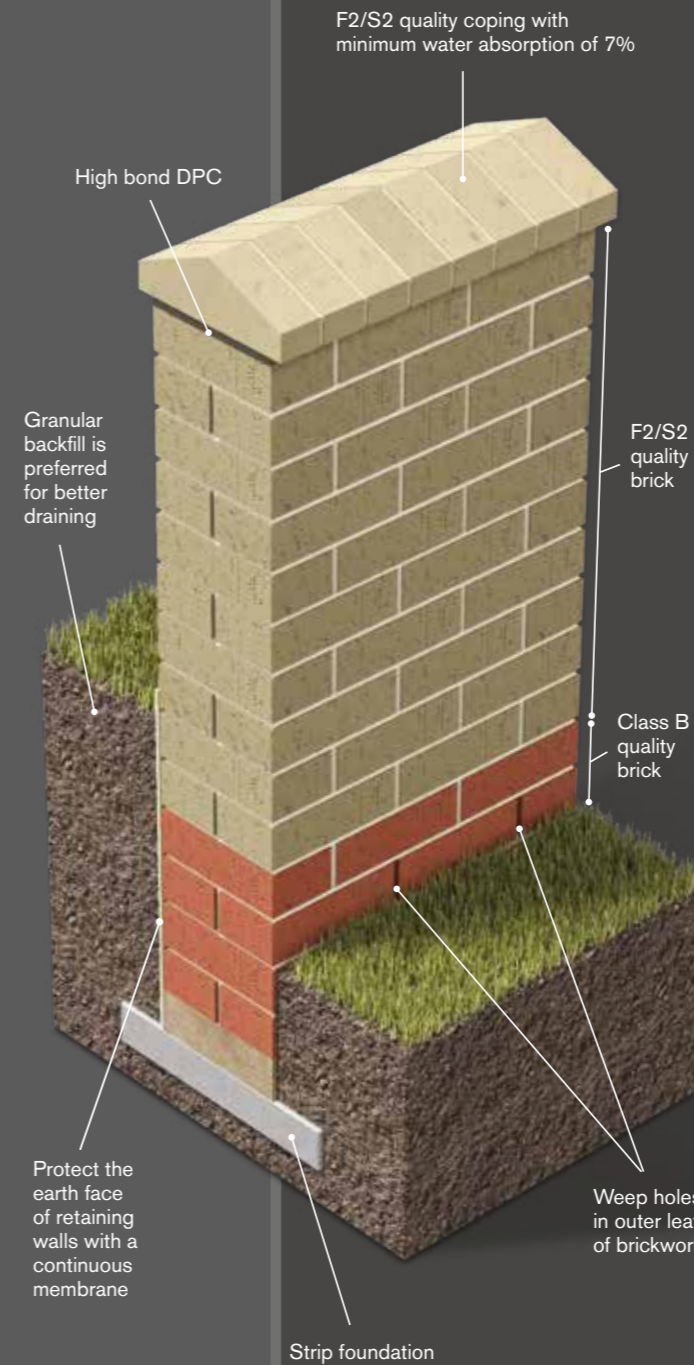

Earth Retaining Walls

Where brickwork is in direct contact with retained earth, it is exposed to ground water which invariably contains salts.

To minimise the risk of efflorescence on the exposed face of the wall, a waterproof barrier between the retained earth and the brickwork should be provided.

The waterproof barrier will also aid the minimisation of frost damage and sulphate attack.

All other detailing should be in accordance with that stated for a freestanding wall.

Rendering of the wall is not recommended under any circumstances.

A cement rich M12 mortar (1:1/4:3 cement:lime:sand or equivalent) should be used for cappings and copings on both freestanding and retaining walls.

A flexible DPC should be avoided at all times as this will reduce overall structural stability.

Frost Attack

In extreme conditions, even frost resistant F2 bricks have been known to fail. Where there is a likelihood of long term saturation during cyclic frost conditions occurring, it is advisable to choose a brick of high strength and low water absorption as an added precaution.

It is important to follow the above-mentioned good building practice details when constructing walls and other vulnerable structures.

Care should always be taken to observe relevant design details and current Codes of Practice.

Design Considerations

Colour Guide

Our range of brick specials can be manufactured to match any brick from our core facing brick range.

The below brick colour samples represent a small selection of our core brick range. To see our full brick range please refer to our Brick Guide or visit forterra.co.uk.

Reds



County Red Smooth



Hampton Rural Blend

Reds

From full-blooded reds, to faded rose or orange and all points in between.

Bufs and Yellows

From richly flecked and variegated buffs, to buttery yellows and iridescent yellow/purple blends.

Browns, Blues, Greys

From the palest taupes and greys, through to inky blue.

Bufs



Belgravia Gault Blend



Tame Valley Buff Dragfaced

Yellows



Ashwell Yellow Multi

Browns



Dark Moroccan Smooth

Blues



Blue Smooth

Greys

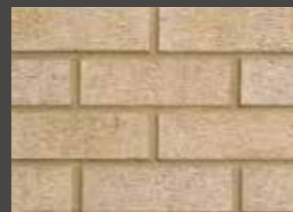

Chatsworth Grey Rustic

Texture Guide

Smooth



Smooth finish or smooth sandfaced finish, consistent and uniform in character.

Light Textured



Modern and uniform, with an indented or printed finish.

Heavy Textured



A harder and rougher texture is given from a rusticated brick with a consistent finish.

Stock - Pressed



A smooth sandfaced finish, consistent and uniform in character.

Stock - Thrown



A slightly irregular shape with a creased texture, replicating the appearance of hand-made bricks.

Tumbled



Distressed and irregular in shape offering an 'olde worlde' charm associated with reclaimed bricks.

Brick Bond Patterns

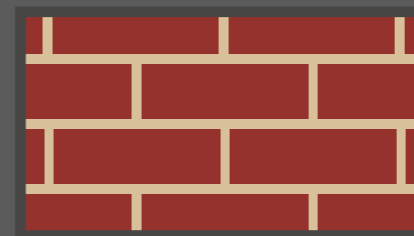

Stretcher bond

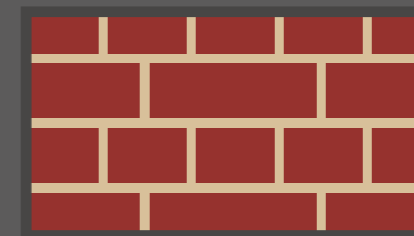

English bond

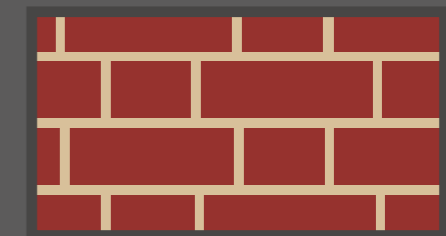

Flemish bond

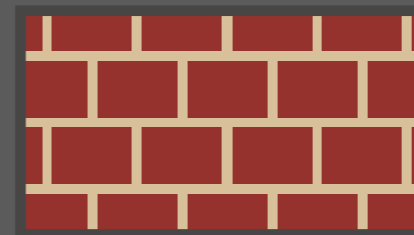

Header bond

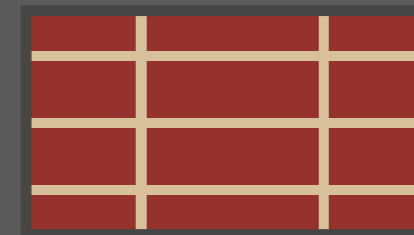

Stack bond

The purpose of bonding is to make brickwork uniform in structure and composition and to maximise its bonding patterns used in the UK. Below are five of the most popular bonding patterns used in the UK.

Design Considerations

Mortar Colours

Mortar colour can have a significant impact on the look of a building as generally mortar represents around 15% of the total visible brickwork area. When choosing mortar colours it may be advisable to construct sample panels on site.

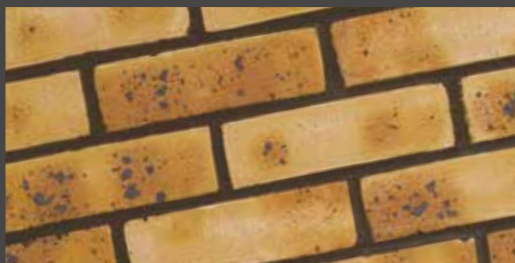

Mortar Joint Profiles

The purpose of finishing joints is to improve the rain resistance and visual appeal of the wall by compacting the surface of the mortar and pressing it into contact with the bricks. Below are five mortar joint profiles commonly used in the UK.

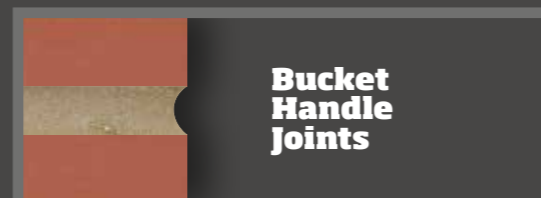
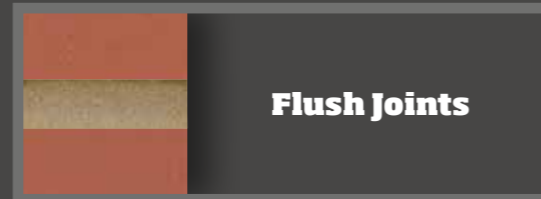

Ordering Information

Brick Specials Check List

- ✓ **Durability**
When ordering, please check that the durability rating of the brick is suitable for its intended application.
- ✓ **Schedule**
It is important to provide a schedule with your requirements. Please check lead times to allow us to work within your building programme.
- ✓ **Design Advice**
Please seek further design advice from our specials department when using copings, cappings and cills in exposed locations, or if you require bespoke specials for specific applications.
- ✓ **Manufacturing Type**
When ordering please state clearly if the format of the special is critical ie frogged, solid or perforated.
- ✓ **Left or Right Handed Bricks**
Certain specials may require to be left or right handed and this should be stated on your order.
- ✓ **Brick Face Requirements**
If a finished face other than those illustrated is required please indicate on your order, as specific requirements can usually be accommodated and priced accordingly.
- ✓ **Brick Variations**
Textural and colour variations may occur with certain specials as they may be manufactured by a different process to the standard product.
- ✓ **Installation Regulations**
Special shapes should be used in accordance with the recommendations contained within BS 5628 Part 3 Code of Practice for use of masonry.
- ✓ **Delivery**
Due to the bespoke nature of our products, quantities per pallet and delivery methods may vary. Please discuss your specific requirements with one of our sales staff, prior to placing your order.

Manufacturing Details

Brick specials are manufactured as either solid, perforated or frogged.

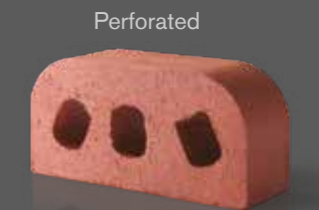

Product Illustrations

The product illustrations shown within this guide represent the specials as solid construction, in order to provide a visual consistency. The darker shading shown on the illustrations represent the face of the brick.

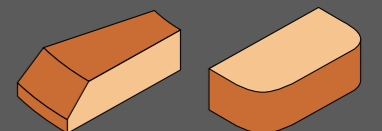

All Cradley special products are manufactured to a quality assurance system which conforms to BS EN ISO 9001:2000. The company has an environmental and sustainability policy and operates an Environmental Management System which fully complies with the requirements of BS EN ISO 14001:1996.

Talk to the Specialists



John Richardson, Cradley General Manager

Our Cradley brick specialists are on hand to assist with any enquiries, technical questions or to discuss your requirements in more detail.

Sales Service and Support

01384 637174 is the only number you need to reach a comprehensive sales and support service. This number puts you in touch with our special co-ordinators, who will respond directly to your enquiry, providing prices, order processing and delivery commitments.

Through the co-ordinators you can also arrange for an account manager to discuss any specific projects, provide samples and give general advice on any of Forterra's product range.

Technical Advisory Service

Fully committed to promoting good practice in the design and use of brickwork, Cradley offer an unrivalled technical support service to all users of its products, working in partnership with its customers to reach the ideal building solution, from beginning to end.

From conception to completion, Cradley can offer advice, technical support and on-site involvement throughout the project's development.

01384 637174
brickspecials@forterra.co.uk
forterra.co.uk/cradley



THE ORIGINAL
LONDON
BRICK

ECOSTOCK
BRICK

BUTTERLEY
BRICK

CRADLEY
SPECIAL BRICK

RED BANK

THERMALITE

CONBLOC

JETFLOOR

INNOVATORS IN
FORMPAVE
PERMEABLE PAVING

BISON PRECAST

forterra.co.uk



Forterra is a leading manufacturer of a diverse range of clay and concrete building products, used extensively within the construction sector, and employs over 1,900 people across 18 manufacturing facilities in the UK.

It is the second largest brick and aircrete block manufacturer in the country, and the only producer of the iconic London Brick. Other trusted brands from Forterra include Thermalite, Conbloc, Ecostock, Butterley, Cradley, Red Bank, Bison Precast, Jetfloor and Formpave.

Cradley

Overend Road
Corngreaves Trading Estate
Cradley Heath
West Midlands
B64 7DD

Tel: 01384 637174

Fax: 01384 637175

Email: brickspecials@forterra.co.uk

forterra.co.uk/cradley

